

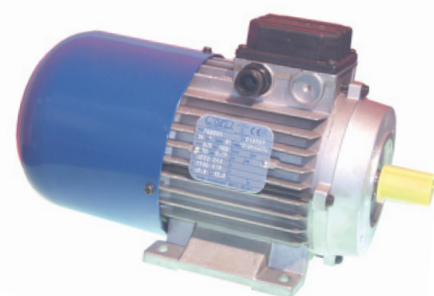

F



FK



SW

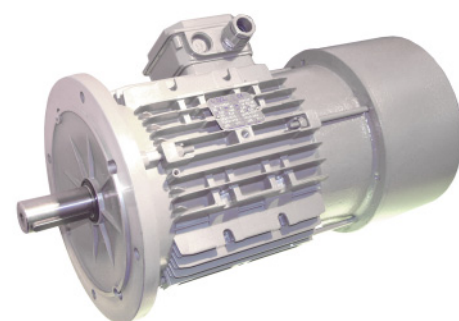

FM



Brake

Electric Motors

General catalogue 2006/01



Coel is a dynamic company having a great experience in the field of electric motors. Coel was born on 1976 mainly making special induction motors. During last ten years we have specialised in designing and producing brake motors having today one of the widest range of products available on the market. More than the standard series production (from frame 56 up to 315), Coel pays particular attention to customised products, offering top competence and flexibility .

Coel makes mechanical workings and assembling in its structures due to guarantee the best possible quality control.



General technical features

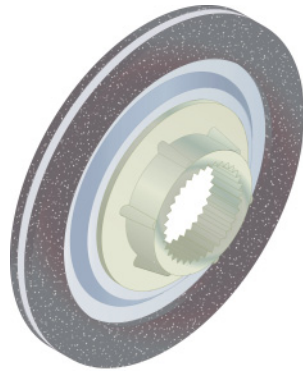

Brake disks

Frictional materials that we use do not contain noxious elements and substances. Brake disks are built with linings whose mixes have been studied to guarantee high braking torque and, at the same time, long brake life.

Stators and Windings

Our purpose is to guarantee that customer will always have maximum yield from our motors; for this reason we use only high quality magnetic plates which help to ensure efficiency and moderate energy consumption. All windings are made with insulation phase by phase.

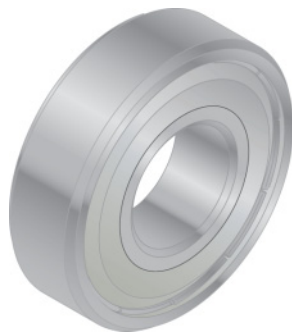
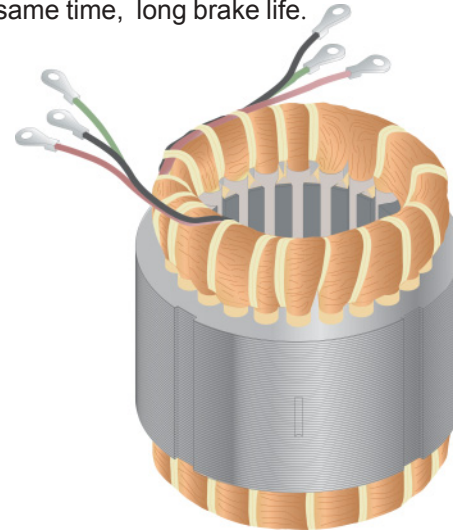

Bearings

Bearings are the component which must withstand the greatest part of mechanical stresses; therefore we use only first quality bearings specifically designed for electric motors.

Motor shafts

On brake motors, the shaft is continuously under spinning and braking stress and consequent radial and torsion loads. For this reason we use only high resistance steel for making our shafts.

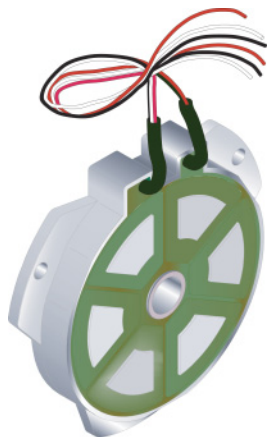

The electromagnets

All the electromagnets are encapsulated with H thermal class epoxy resin to give total protection. Our experience showed that protecting the electromagnets with resin, we obtained the best possible reliability.

Performance data

Rating: refers to the mechanical power measured at the shaft expressed in Watts or in Horsepower (HP).

Voltage rating: refers to the tension applied to the motor terminals and it's indicated on the motor rating plate.

Phase angle: in the three-phase electric power supply system it corresponds to the angle between voltage vector and current vector; it is indicated with the Greek character "φ" and its cosine is the value that identifies the power factor.

Efficiency: it is given by the ratio between actual power absorbed by the motor and that yielded, and is expressed in percentage.

Synchronism speed: it is obtained by the formula

$$n^{\circ} = \frac{f120 \text{ rpm / min}}{p}$$

f = power supply frequency

p = number of poles

Starting torque: the minimum torque that the motor can provide with a blocked rotor, with voltage rating feed and rated frequency.

Maximum torque: refers to the maximum torque the motor can develop while it operates with voltage rating feed and rated frequency.

Torque rating: refers to the torque that corresponds to the rating and the turn rating. The value of the torque rating is obtained by the formula:

$$Mn = 9554 \frac{Pn}{n} \text{ (Nm)}$$

Pn = is the rating expressed in KW

n = is the speed of rotation expressed in revs per minute

Tolerances (see "overall dimensions" in this catalogue)

Shaft ends: the 'D' form, for all constructive forms, is subject to the following tolerances:

mm	9-28	30-48	over than 49
tolerance	j6	k6	m6

Flange: the 'N' dimension, both for the B5 and B14 forms and their derivatives, is subject to a j6 tolerance up to including the 230 mm diameter; h6 tolerance for larger diameters.

To understand the meaning of the j6, k6, m6 symbols, see norm UNI 4679. For the sizes of the side keys corresponding to the diameter of every shaft end, see norm UNEL Pr 1720.

Motor bearings

Type	Frame	Front side	Back side
FK	56	6201ZZ	6201ZZ
FK	63	6202ZZ	6202ZZ
FK	71	6202ZZ	6203ZZ
F	71	6203ZZ	6004ZZ
F-FK	80	6204ZZ	6204ZZ
F-FK-SW	90	6205ZZ	6205ZZ
F-FK-SW	100	6206ZZ	6205ZZ
F-FK-SW	112	6207ZZ	6207ZZ
F-SW	132	6308ZZ	6208ZZ
F-SW	160	6309ZZ	6309ZZ
F	180	6311ZZ	6211ZZ
F	200	6312ZZ	6312ZZ

Type	Frame	Front side	Back side
FM	225	6313 C3	6313 C3
FM	250	6314 C3	6314 C3
FM	280	6316 C3	6316 C3
FM	315	6318 C3	6318 C3

Type of duty

Continuous duty (S1): the motor operates at a constant charge for the length of time sufficient to reach a thermal balance.

Limited duration duty (S2): the motor operates at a constant charge for a limited length of time insufficient to reach a thermal balance. There then follows a period of rest big enough to allow the motor to return to room temperature.

Periodic alternating duty (S3): the motor operates according to a cycle including a period of time at a constant charge (t_s) and the rest time (t_r). The synthetic indication of duty is provided by the percentage intermittence ratio compared to the length of reference time which is normally 60 minutes (ex. 15% - 60 min).

$$\text{intermittence ratio} = \frac{t_s}{t_s + t_r} \cdot 100 (\%)$$

Periodic alternating duty with start-ups that affect the heating of the motor (S4): the motor operates according to a cycle that includes a notable start-up time (t_a), operating time at a constant charge (t_s) and a reest time (t_r). In this case, the synthetic condition of the duty must be accompanied by the number of inserts per hour.

$$\text{intermittence ratio} = \frac{t_a + t_s}{t_a + t_s + t_r} \cdot 100 (\%)$$

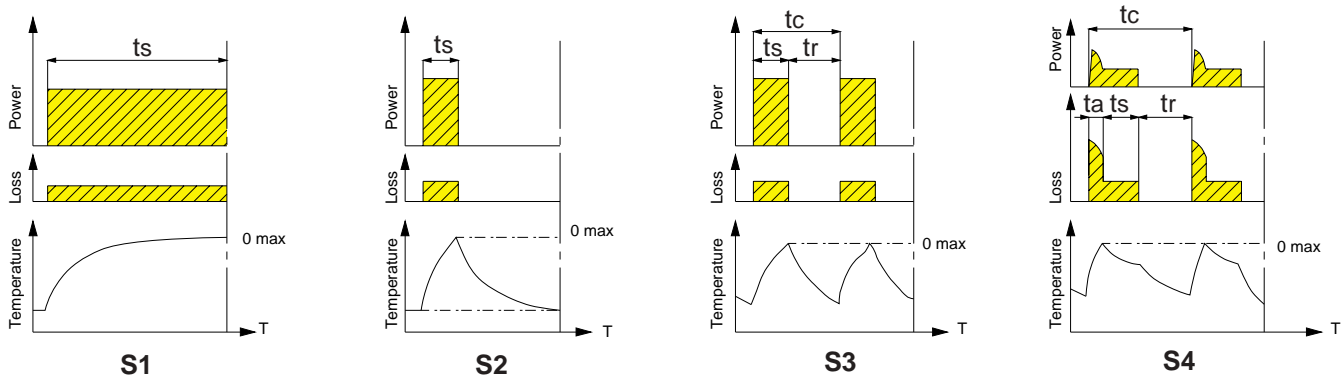

- t_c Cycle duration
- t_a Start-up and acceleration time
- t_s Operating time at a constant power
- t_r Rest time
- 0_{max} Maximum temperature reached

Motors operating at 60 Hz

A motor coiled up for a certain tension at 50 Hz can be used also at 60 Hz without modifications.
In this case, the motor data change as indicated in the following tab:

Motor Coiled for 50Hz	Connected at 60Hz	Data at 60 Hz as % of values at 50 Hz						
		power	rpm	I_N	I_s/I_N	T_N	T_s/T_N	T_{max}/T_N ¹⁾
220 V	220 V	100	120	98	83	83	70	85
	255V	115	120	100	100	96	95	98
380 V	380 V	100	120	98	83	83	70	85
	415 V	110	120	98	95	91	85	93
	440 V	115	120	100	100	96	95	98
	460 V	120	120	100	105	100	100	103
400 V	380 V	100	120	100	80	83	66	80
	400 V	100	120	98	83	83	70	85
	415 V	105	120	100	88	86	78	88
	440 V	110	120	100	95	91	85	93
	460 V	115	120	100	100	96	95	98
	480 V	120	120	100	105	100	100	100
415 V	415 V	100	120	98	83	83	70	85
	460 V	110	120	98	95	91	85	94
	480 V	115	120	100	100	96	95	98
500 V	500 V	100	120	98	83	83	70	85
	550 V	110	120	98	95	91	85	94
	575 V	115	120	100	100	96	95	98
	600 V	120	120	100	105	100	100	103

Performance, power factor and the over-the-limit temperature will more or less be similar to the ones for 50 Hz

- 1) I_N = rated current
 I_s/I_N = start up current/rated current
 T_N = torque rating
 T_s/T_N = maximum torque/torque rating
 T_{max}/T_N = start up torque/torque rating

Asynchronous motors - structure

Fixing manners and positions (IEC 34-7)

Motors with feet
* all sizes

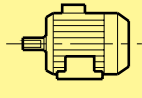
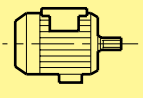
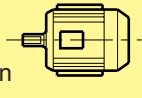
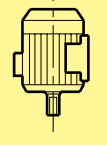
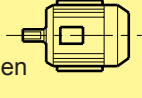
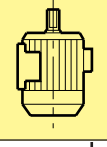
<p>IM 1001 (IM B3) - Horizontal shaft - Feet on the floor</p> 	<p>IM 1071 (IM B8) - Horizontal shaft - Feet upwards</p> 
<p>IM 1051 (IM B6) - Horizontal shaft - Feet resting against the wall on the left seen from the shaft end</p> 	<p>IM 1011 (IM V5) - Shaft vertical downwards - Feet against the wall</p> 
<p>IM 1061 (IM B7) - Horizontal shaft - Feet resting against the wall on the right seen from the shaft end</p> 	<p>IM 1031 (IM V6) - Shaft vertical upwards - Feet against the wall</p> 

Flanged motors with through fastening holes

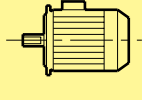
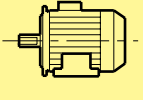
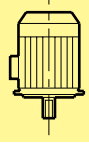
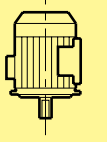
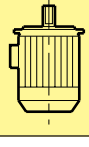
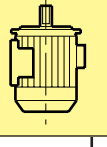
<p>IM 3001 (IM B5) - Horizontal shaft</p> 	<p>IM 2001 (IM B35) - Horizontal shaft - Feet on the floor</p> 
<p>IM 3011 (IM V1) - Shaft vertical downwards</p> 	<p>IM 2011 (IM V15) - Shaft vertical downwards - Feet against the wall</p> 
<p>IM 3031 (IM V3) - Shaft vertical upwards</p> 	<p>IM 2031 (IM V36) - Shaft vertical upwards - Feet against the wall</p> 

Flanged motors with threaded fastening holes

* Axis height ≤ 160 mm

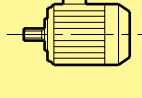
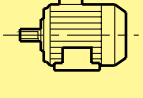
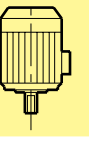
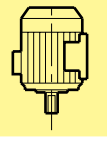
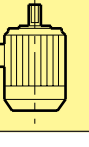
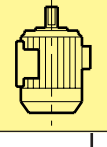
<p>IM 3601 (IM B14) - Horizontal shaft</p> 	<p>IM 2101 (IM B34) - Horizontal shaft - Feet on the floor</p> 
<p>IM 3611 (IM V18) - Shaft vertical downwards</p> 	<p>IM 2111 (IM V58) - Shaft vertical downwards - Feet against the wall</p> 
<p>IM 3631 (IM V19) - Shaft vertical upwards</p> 	<p>IM 2131 (IM V69) - Shaft vertical upwards - Feet against the wall</p> 

No flange motors

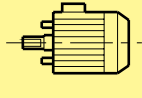
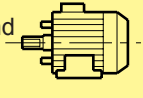



<p>IM 9101 (IM B9) - With threaded fastening rods - Horizontal shaft</p> 	<p>IM 1201 (IM B15) - With fastening feet and threaded rods - Horizontal shaft</p> 
---	---







Asynchronous motors - ambiance

Definition of protection levels

All electric machines are signed with a protection level (IP) - IEC34-5 (EN60034-5)

- **F / FK / FM series motors are IP54 as standard and higher on request**
- **SW series motors are IP56 as standard**

1st digit : protection from solid bodies		
IP	Test	Definition
0		No protection
1	ø 50 mm. 	Protected from solid bodies thicker than 50 mm (ex: unintentional contact with hands)
2	ø 12 mm. 	Protected from solid bodies thicker than 12 mm (ex.: finger)
3	ø 2.5 mm. 	Protected from solid bodies thicker than 2,5 mm (ex.: tools, cables)
4	ø 1 mm. 	Protected from solid bodies thicker than 1 mm (ex.: small tools, thin wires)
5		Protected from dust (ex.: no noxious deposits)

1st digit : protection from water		
IP	Test	Definition
0		No protection
1		Protected from vertically falling drops (condense)
2	15° 	Protected from drops falling up to 15° from the vertical
3	60° 	Protected from rain drops falling up to 60° from the vertical
4		Protected from water projections from any direction
5		Protected from water sprayed from any direction with a nozzle
6		Protected from water projections similar to sea waves.

Asynchronous motors - ambiance

Operation on the basis of environmental conditions (temperature, altitude)

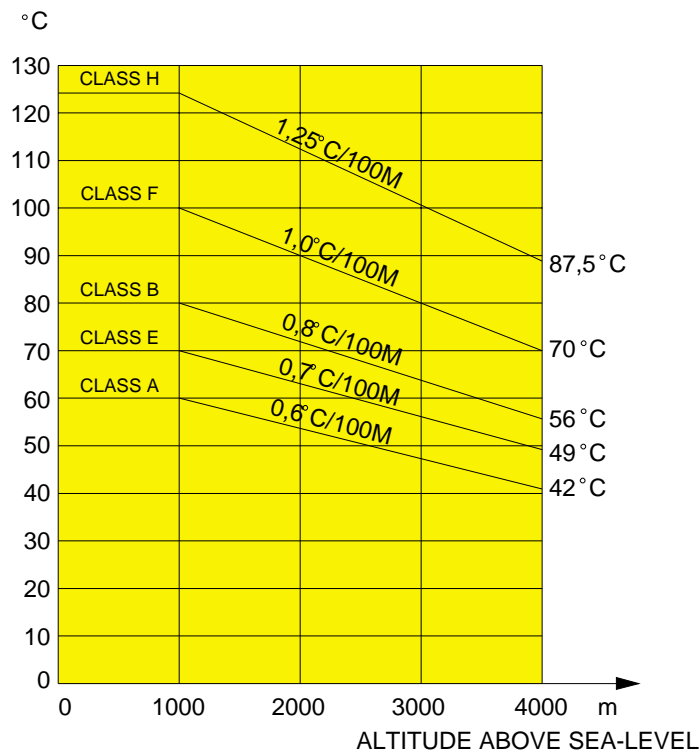

Limits in excess temperatures depending on the altitude at installation for trials carried out at altitudes less than 1000m, for machinery meant for installation at up to 4000m (coolant temperature 40°C).

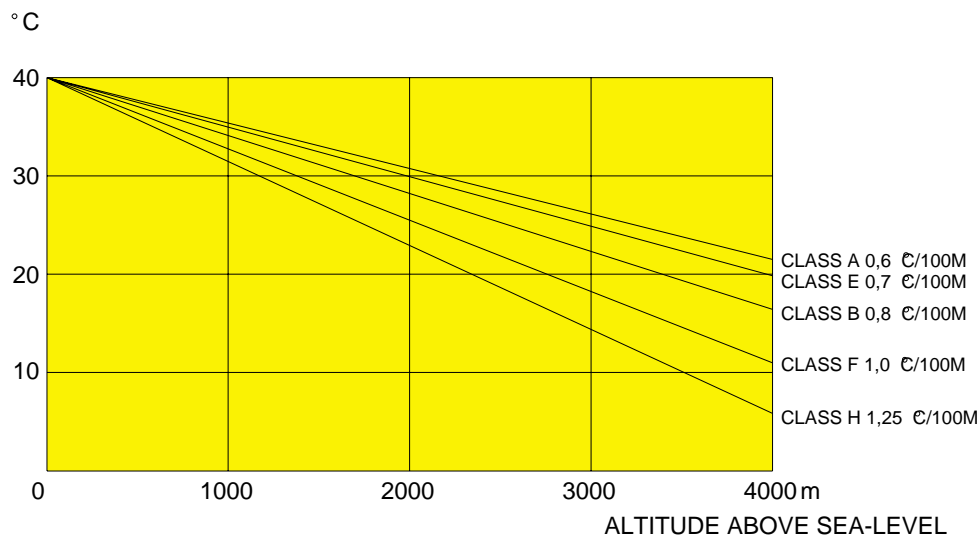

Changes in temperature of cooling air depending on altitude necessary for maintaining the excess temperature, valid up to 100m, also for altitudes between 1000 and 4000m.

In order to protect the motor from too high temperatures in some cases it is suggested to use Thermal resistors or PTC.

COEL motors are insulated in F class as standard feature (higher on request)

Rectifiers for DC brakes

All the motors fitted with DC brake are supplied with a rectifier into the terminal box or mounted on one of the cable glands holes of the case. All rectifiers are protected from the over-voltages and made to guarantee high reliability in every application.

The rectifier value voltage input of single speed motors is the same of the delta connection motor voltage.

Two speeds motors are fitted as standard with two terminal boards (separated brake supply). In this case the voltage to the "AC 1ph. In" terminals of the rectifiers will be the same of the motor.

In case of separated brake supply for single speed motors or for special needs, the voltage of the brake has to be specified by the customer. The time brake release, can be reduced using a "fast connection" of the rectifier.

In this case it will be necessary to ask for special rectifier.

Connection of the standard rectifiers

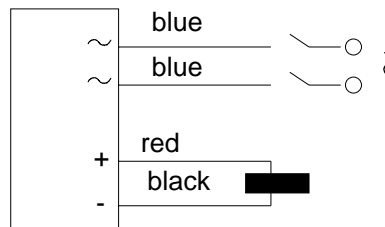

Brakes time response

All brake groups up to 300Nm mounted on our motors are designed and made by COEL in order to guarantee a designing homogeneity and a constant check on every component of the product.

The F series AC brake is suggested for applications in which a very fast response of the brake and high braking torque values are necessary. F brakes are also available with DC electromagnets.

The FK series with DC brake will be a good choice for "non stressed" application when lower brake torque is needed, or when a very low noise of the brake is needed.

Some indicative values of time response of brakes are the following :

Type	AC brake (ms)	DC brake (ms)	DC brake (fast connection) (ms)
F71-80-90-100	7	70	15
F-112	9	70	20
F132-160-180-200	12	80	25
FK56-63-71-80	-	60	25
FK90-100-112	-	70	30
FM 225 - 315	-	1400	100

- The time response of the brake can be reduced of 30 - 50 % (depending on type of brake) if it's is supplied separately from the motor.

- SW series motors are fitted with FK brakes for frame 90/100 and F for frames 112/160 .

Braking times can be indicatively determinated by the following formula:

$$\frac{J_{tot} \times n}{9.55 (M_f \pm M_{load})} + \frac{t_x}{1000}$$

where

Jtot: inertia moment at the motor shaft (Kgm²)

n: speed r.p.m.

Mf: braking moment (Nm)

Mload: resistant moment to the load applied (Nm), positive or negative depending on concordance with braking moment.

tx: brake time response (ms)

Installation and maintenance

Correct installation of the motor and of the mechanical components coupled with it is the indispensable condition for correct motor operation and long life.

The motor should be handled with care, avoiding all hard blows, particularly to the shaft.

Before coupling the motor with other mechanical components be sure that all parts interested by the coupling itself have been accurately cleaned and eventually treated with the special products.

The motor should be installed in a position that permits correct ventilation of the same: the air flow should therefore not be hindered; check that flatness and axiality between joints is perfect and always connect the earth wire.

Verify that the electrical system and the section of the cables necessary to supply power to the motor are suitable to the starting up as indicated by the plate ratings.

COEL motors are projected to reduce maintenance as much as possible; we suggest, anyway, periodical cleaning of the motor (of its shell as well), particularly when the motor operates in especially dusty and dirty environments.

We suggest, for a right operation of the braking group and consequent long motor life, that the magnetic gap between mobile anchor and electromagnet be periodically adjusted: it should never overstep the value of 0,5 mm (we suggest a check every 6 months and, at any rate, not over 500.000 brakings – see specific instructions in the present catalogue).

Anyway, installation, inspection and maintenance of the electric motors should be undertaken only by specialized technical staff (for the definition of technical staff see IEC 364, CEI 64-8, EN 60204-1) only once all electrically powered machine parts have been disconnected.

If you don't take the necessary safety, inspection and maintenance measures could cause damages to persons and things; it is part of the duties of the specialized personnel to inform the maintenance and plant supervisor(s) of eventual anomalies, such as excessive vibrations, high level noises, absorption higher than rating, motor temperature levels higher than usual.

All COEL motors are supplied with the relevant use and maintenance instruction manual; for any additional technical information contact COEL MOTORI S.r.l.

Warranty

COEL MOTORI S.r.l., thanks to the rigorous controls to which materials and construction phases are subject, is able to maintain within a statistically very low value the percentage of motors returned under warranty.

Should any imperfection or defect turn up, either electrical or mechanical, which we recognize are not due to customer's lack of skill in installing or using the motor itself, COEL MOTORI S.r.l. pledges itself to restore its products, free of charges, with the shortest possible delay; all repairs and pieces of work covered by warranty must be effected in our factory.

Warranty period amounts to 12 months beginning on delivery date and in no instance, even if the motor has not been used, can warranty terms be protracted.

Reference norms

Reference	Date	Contents
IEC 34-1	1994	Rotary electrical machines: ascribed and operating features
IEC 34-5	1981	Rotary electrical machines: classification of protection levels as provided by coating protection indexes for electrical machines
IEC 34-6	1991	Rotary electrical machines (except traction): cooling methods
IEC 34-7	1992	Rotary electrical machines (except traction): symbols for constructive forms and assembly devices
IEC 34-8	1972	Rotary electrical machines: identification of farthest point and rotation direction
IEC 34-9	1997	Rotary electrical machines: noise levels
IEC 34-12	1999	Starting features of casing-structured three-phase asynchronous motors, single speed, 50 Hz and tension lower than or equal to 660 V
IEC 34-14	1996	Rotary electrical machines: mechanical vibrations in some machines with axis height higher than or equal to 56 mm. Measurement, evaluation and limits of vibration intensity
IEC 38-1	1994	IEC standard tensions
IEC 72-1	1991	Dimensions and power ranges of rotary electrical machines: designation of frameworks between 56 and 400 and of flanges between 55 and 1080
IEC 34-2	1996	Determination methods using loss and performance tests
IEC 892	1987	Consequences of an unbalanced tension systems on features of casing-structured three-phase asynchronous motors.
IEC 1000	1990	Electromagnetic compatibility (CEM): environment
IEC 106Guide	1989	Guide to specification of environmental conditions for fixing of the materials functioning features
IEC 721-2-1	1982	Classification nature's environmental conditions. Temperature and humidity.
IEC 85	1984	Thermal evaluation and classification of electrical insulation

Reference norms

Correspondence of IEC norms with other norms

IEC norms		OTHER REFERENCE NORMS					
IEC	TITLE (memorandum)	CENELEC	CEI/UNEL	BS	NFC	DIN/VDE	DEC
34-1	Ascribed and operating features	EN60034-1	CEI2-3	BS499-101	NFC51-111	VDE0530-1	UNE 201131-95
34-2	Determination of losses and performance	HD532	CEI2-6	BS4999-34	NFC51-112	VDE0530-2	UNE 20116-74
34-5	Classification of protection levels	EN60034-5	CEI2-16	BS4999-20	NFC51-115	VDE0530-5	IR-89 20111-5
34-6	Cooling methods	EN60034-6	CEI2-7	BS4999-21		DIN IEC 34-6	UNE 20125-741
34-7	Constructive forms and assembly arrangement	EN60034-7	CEI2-14	BS4999-22	NFC51-117	DIN IEC 34-7	UNE 20112-1-74 20112-2-74
34-8	Identification of farthest point and rotation direction	HD53.8 S4	CEI2-8	BS34999-3	NFC51-118	VDE0530-8	UNE 20113-8-96
34-9	Noise levels	EN60034-9	CEI2-24	BS4999-51	NFC51-119	VDE0530-9	UNE 20121-75
34-12	Starting features of single speed motors fed by 660V. tension	EN60034-12	CEI2-15	BS4999-112		VDE0530-12	UNE 20162-83
34-14	Mechanical vibrations in machines with axis height > 56mm	HD53.14 S1	CEI2-23	BS4999-50	NFC51-111	DIN ISO 2373	UNE 20180-86
72-1	Dimensions and power ranges in machines between 56 and 400 and flanges between 55 and 1080	HD231	UNEL 13113 UNEL 13117 UNEL 13118	BS4999-10	NFC51-110 NFC51-120	DIN42673 DIN42677	UNE 20106-2-74 20106-240-80 20106-2-74 20106-2-IC-80

All COEL Motors are CE marked as they conform to EC directives 73/23 low tension, EC 89/336 and subsequent amendment EC 92/31 and EC 93/68.

cCSAus motors are available on request

F-SERIES

Asynchronous brake motors

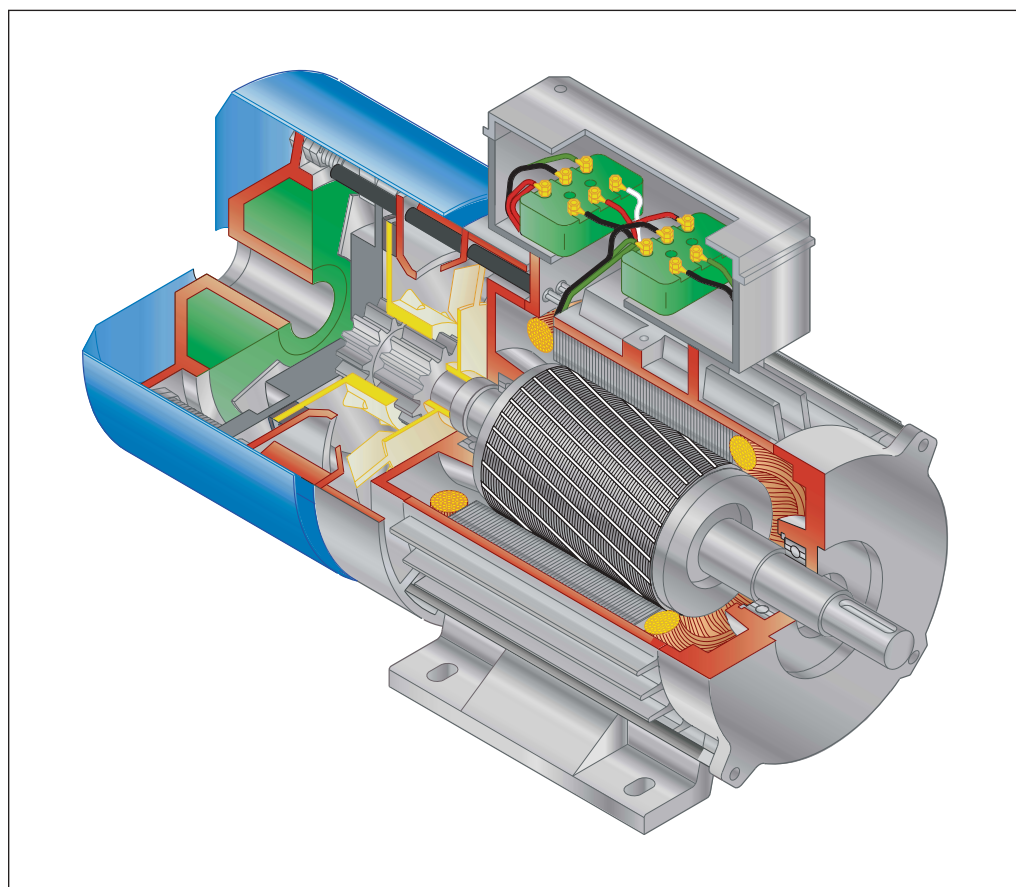

Coel motors are closed and externally ventilated. The brake groups and all the motor parts are made by Coel. The brake group is supplied on series with "3ph. AC" electromagnet but DC version is also available on request. The F series motors can be driven by inverter but in this case the brake supply must be separated from the one of the motor.

The cases of motors are in die cast pressed aluminium from 71 to 160 frame and in cast iron for frames 180 and 200. The shafts of frames 71 to 160 are fitted with an hexagon on the back side for the manual rotation of the shaft. The brake can be manually released with a special screw supplied with the motor. The friction tracks are in cast iron and auto ventilated. The F series motors are designed for very heavy duty cycles.

Features

- Disk brake without axial sliding of the shaft.
- Adjustment of braking torque within very large values.
- Three phase electromagnet as standard
- F motors are supplied with screw for the manual release of the brake, thickness gauge for the adjustment of the magnetic gap of the brake group and hexagon on the rear end of the shafts, for its manual rotation.

F-SERIES

Asynchronous brake motors

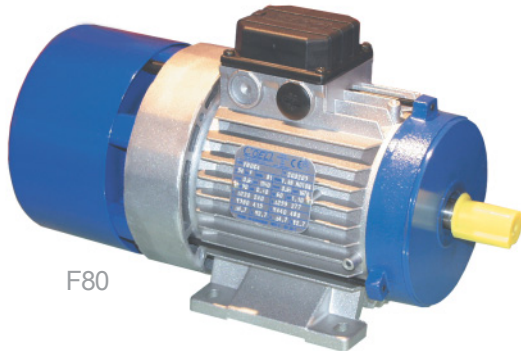

F80

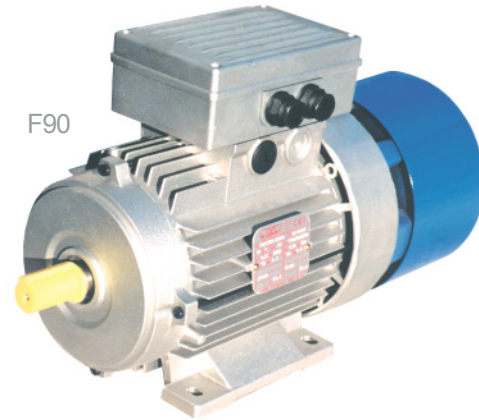

F90

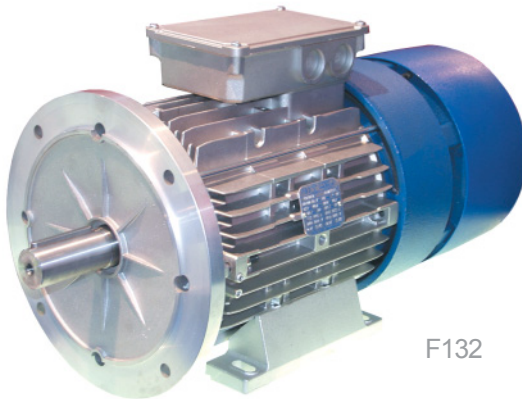

F132

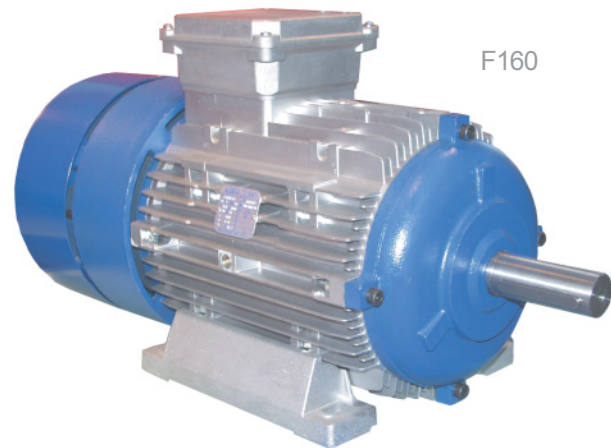

F160

Possible product configurations

- Foot mounted B3
- Motors with feet and flange
- Motors with flange B5 or B14
- Motors with B5 reduced flange from frame 71 to 160
- Motors with B14 reduced flange from frame 71 to 100
- Reduced shafts
- Double shafts
- Special shafts
- Motors B3 with lateral terminal box (up side as standard)
- Customized executions
- Special windings
- Version with forced ventilation
- Separated brake supply
- DC brake
- FL series with progressive start up
- Insulation in H class
- IP 55 protection
- Special "P" rotor for start up torque increasing
- Special painting
- Thermal protections
- Condense resistors
- R or S level balance of the rotor
- With encoder

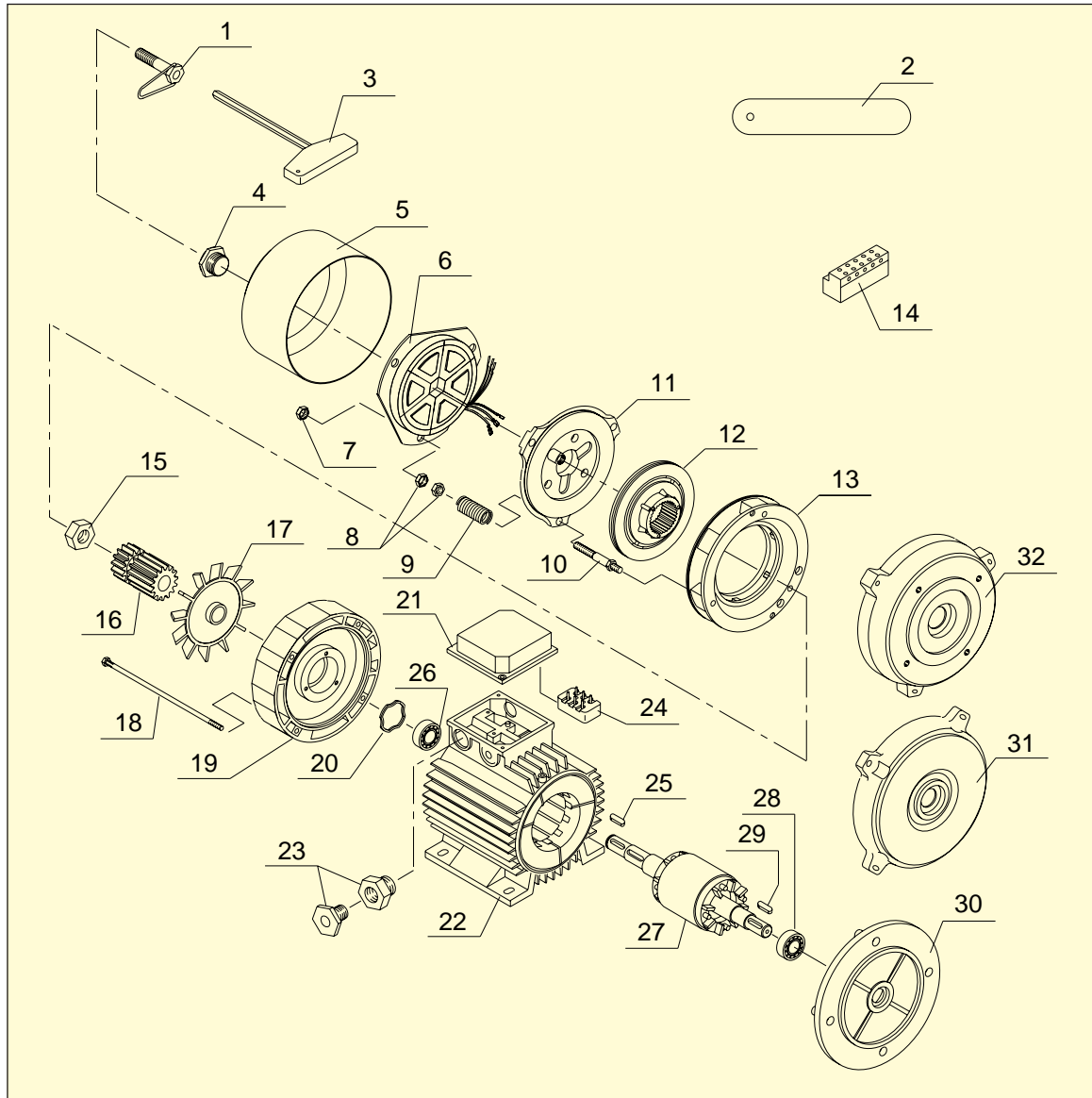
*F Spare parts**Please indicate number of item to order*

1 Manual release screw	18 Drawrods with nuts
2 0,3 mm thickness gauge	19 Brake side shield
3 Key for manual rotation	20 Compensation ring
4 Cap locking screw	21 Single or double terminal board box
5 Brake protection cover	22 Motor case
6 Electromagnet (AC or DC)	23 Cable gland
7 Magnet locking nut	24 Terminal board
8 Adjustment nuts	25 Brake side key
9 Brake springs	26 Brake side bearing
10 Guide stud bolt	27 Rotor shaft group
11 Mobile anchor	28 Control side bearing
12 Brake disk	29 Control side key
13 Conveyor with friction track	30 B5 flange
14 Rectifier (half or full wave)	31 B3 shield
15 Seeger or gear locking ring	32 B14 flange
16 Brake Gear	
17 Fan	

F series braking group maintenance

for more information see www.coelmotori.it

Magnetic gap adjustment

Magnetic gap 40 (the distance between the electromagnet and of the mobile anchor) must be regulated at approximately mm. 0,3.

The agnetic gap should be periodically checked. In order to adjust the magnetic gap , turn the couples of nuts (7-8) moving the electromagnet to the mobile anchor. When the magnetic gap has been adjusted check that nuts have been correctly locked.

Replacing the electromagnet

Remove screw 4, remove cap 5, disconnect the 6 terminals of the magnet, remove the three nuts 7 and slip electromagnet 6 off stud bolts 10.

Slip the new electromagnet on to the stud bolts, making sure that, when reinserting the terminals the colours do not match.

Tighten nuts 7-8 and check that the new electromagnet operates regularly.

Replacing the brake disk

Loosen nut 4, remove cap 6 and loosen the three nuts 7 without detaching the terminals. Remove nuts 8 and spring 9. Mount the new brake disk.

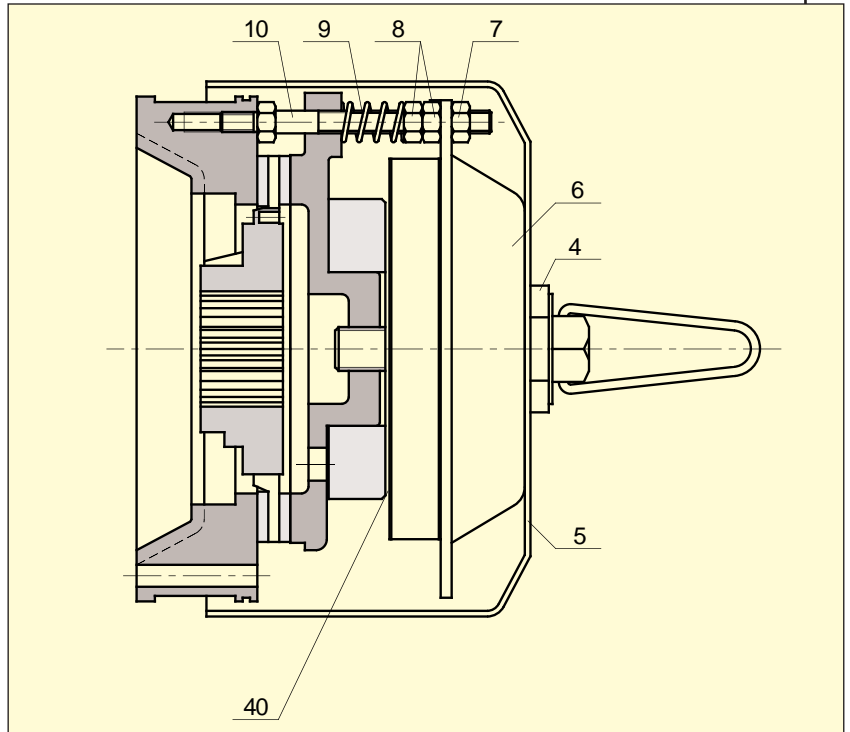

Braking torque adjustment

Braking torque is proportional to the compression of springs 9; such compression can be modified working on nuts 8 (lunscrew to decrease, screw to increase). Compression of the three springs must be uniform.

See the indicative following description to adjust the braking torque values. Different or lower values than indicated are available on request.

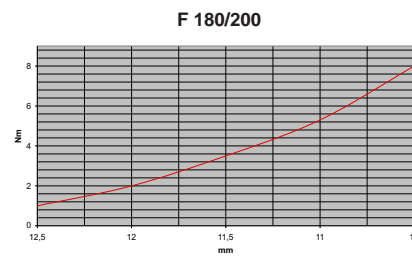
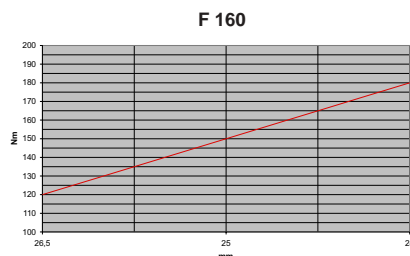
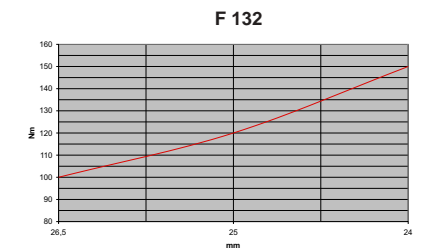
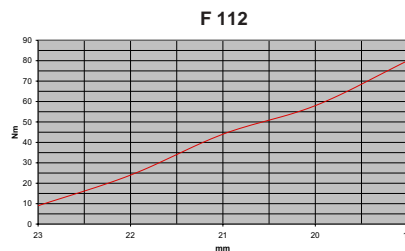
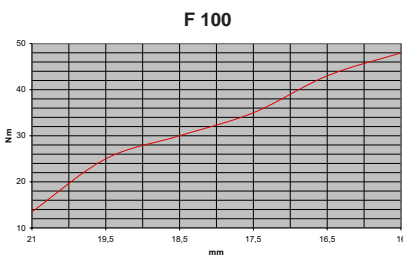
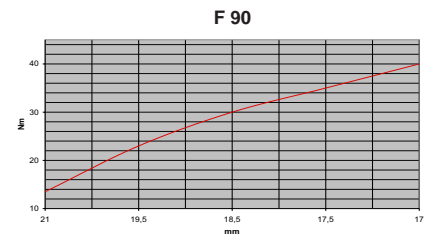
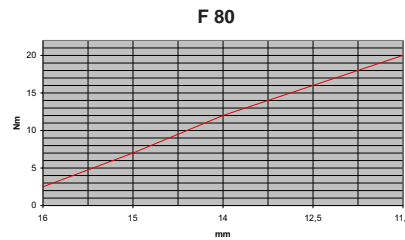
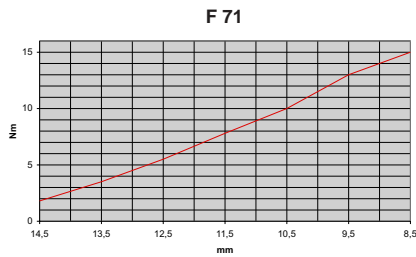

Three phase 2 poles - 3000 r.p.m.

Type	kW	r.p.m.	Cos. ϕ	I n V.400	Ma/Mn	I.A/I.N	Inertia moment Jx Kgm ²	Braking Torque MAX Nm.	Starts C/h	A.V.400 Brake A.C. (m A)	A. V.230AC brake D.C. (m A)	KG.
F71A2	0,37	2765	0,79	1,10	2,5	3,9	0,00071	15	6000	110	90	9,5
F71B2	0,55	2780	0,79	1,50	2,5	3,9	0,00082	15	5000	110	90	10,5
F71C2*	0,75	2780	0,76	2,10	2,3	4,3	0,00098	15	4000	110	90	11,5
F80A2	0,75	2780	0,77	2,00	3,0	4,8	0,00146	20	6000	180	180	14,4
F80B2	1,10	2780	0,82	2,90	3,0	4,9	0,00129	20	5300	180	180	15,5
F90SA2	1,50	2780	0,86	3,50	2,5	6,8	0,00189	40	4000	250	250	20
F90SB2	1,84	2780	0,86	4,30	2,5	6,8	0,00200	40	3500	250	250	21,5
F90LA2	2,20	2800	0,88	4,70	2,5	6,8	0,00232	40	3000	250	250	23
F100LA2	3,00	2800	0,88	6,50	2,9	8,0	0,00572	48	1200	250	250	28
F112MB2	4,00	2820	0,87	8,20	2,4	7,4	0,00720	80	900	500	550	47
F132SA2	5,50	2880	0,85	11,0	2,3	7,5	0,03100	150	500	800	600	78,5
F132SB2	7,50	2880	0,85	15,0	2,3	7,5	0,03320	150	500	800	600	84,5
F132MA2*	9,20	2870	0,88	18,0	2,3	7,5	0,03980	150	500	800	600	94,5
F132MB2*	11,00	2870	0,89	21,0	2,3	7,5	0,04620	150	500	800	600	100
F160MA2	11,00	2890	0,88	20,8	3,0	9,0	0,06020	175	300	800	600	120
F160MB2	15,00	2900	0,87	29,0	3,0	8,0	0,06260	175	300	800	600	130
F160LA2	18,50	2900	0,90	33,0	3,0	8,0	0,08960	175	290	800	600	150
F180LA2	22,00	2940	0,90	39,0	2,0	7,5	0,16800	300	190	800	600	210
F200LA2	30,00	2950	0,90	53,0	2,0	7,5	0,20000	300	190	800	600	230
F200LB2	37,00	2950	0,89	65,5	2,0	7,5	0,21000	300	190	800	600	250

*non unified powers

- 1) Motors from frame 71 to 132 are supplied with voltage at 220/380/50 240/415/50 255/440/60 277/480/60
- 2) Motors frame 160, 180, 200, are supplied as series with motor at V.400/690/50 and electromagnet at V.230/400/50
- 3) The braking torque values can be reduced of about 10% if the electromagnet is DC.

Three phase 4 poles - 1500 r.p.m.

Type	kW	r.p.m.	Cos. φ	I n V.400	Ma/Mn	I.A/I.N	Inertia moment Jx Kg m^2	Braking Torque MAX Nm.	Starts C/h	A.V.400 Brake A.C. (m A)	A. V.230AC brake D.C. (m A)	KG.
F71A4	0,25	1400	0,65	0,9	2,70	3,9	0,00071	15	19500	110	90	9,5
F71B4	0,37	1390	0,70	1,2	2,70	4,1	0,00082	15	18000	110	90	10,5
F71C4*	0,55	1360	0,72	1,7	2,30	3,1	0,00098	15	15000	110	90	11,5
F80A4	0,55	1390	0,68	1,7	2,30	4,0	0,00146	20	10000	180	180	14
F80B4	0,75	1400	0,70	2,2	2,60	4,2	0,00173	20	10000	180	180	15,5
F80C4*	0,90	1390	0,69	2,7	2,50	4,3	0,00185	20	9000	180	180	16,5
F90SA4	1,10	1400	0,77	2,7	2,30	4,6	0,00284	40	10000	250	250	21
F90LA4	1,50	1400	0,75	3,7	3,00	4,9	0,00305	40	10000	250	250	23
F90LB4*	1,85	1400	0,77	4,3	3,00	4,6	0,00388	40	9000	250	250	24
F90LC4*	2,20	1400	0,78	5,4	2,90	4,3	0,00430	40	8000	250	250	26
F100LA4	2,20	1410	0,78	5,0	2,70	5,5	0,00572	48	7500	250	250	28
F100LB4	3,00	1410	0,82	6,4	2,70	5,0	0,00612	48	7000	250	250	32
F100LC4*	3,30	1410	0,80	7,5	2,60	4,7	0,00750	48	7000	250	250	34
F112MB4	4,00	1430	0,85	8,2	2,70	5,8	0,01180	80	3300	500	550	47
F132SB4	5,50	1440	0,81	11,3	2,60	5,8	0,03320	150	1200	800	600	84,5
F132MA4	7,50	1430	0,85	14,6	2,30	5,8	0,03900	150	1000	800	600	94,5
F132MB4*	9,00	1430	0,84	17,9	2,30	5,8	0,04620	150	900	800	600	100
F160MB4	11,00	1460	0,80	22,0	2,80	5,9	0,06260	175	600	800	600	130
F160LA4	15,00	1460	0,82	29,0	2,30	5,9	0,08960	175	600	800	600	150
F160LB4*	18,50	1450	0,83	37,0	2,20	5,8	0,09480	175	600	800	600	170
F180LA4	18,50	1470	0,85	34,5	2,20	7,5	0,1670	300	540	800	600	210
F180LB4	22,0	1470	0,86	39,8	2,20	7,5	0,1990	300	530	800	600	230
F200LB4	30,0	1470	0,86	53,1	2,20	7,2	0,1213	300	300	800	600	250

*non unified powers

- 1) Motors from frame 71 to 132 are supplied with voltage at 220/380/50 240/415/50 255/440/60 277/480/60
- 2) Motors frame 160, 180, 200, are supplied as series with motor at V.400/690/50 and electromagnet at V.230/400/50
- 3) The braking torque values can be reduced of about 10% if the electromagnet is DC.

Three phase 6 poles - 1000 r.p.m.

Type	kW	r.p.m.	Cos. ϕ	I n V.400	Ma/Mn	I.A/I.N	Inertia moment Jx Kgm ²	Braking Torque MAX Nm.	Starts C/h	A.V.400 Brake A.C. (m A)	A. V.230AC brake D.C. (m A)	KG.
F71A6	0,18	900	0,69	0,8	1,9	2,5	0,00091	15	22000	110	90	9,5
F71B6	0,25	910	0,69	1,0	2,0	2,5	0,00123	15	22000	110	90	10,5
F71C6*	0,30	900	0,68	1,2	1,9	2,6	0,00141	15	19000	110	90	11,5
F80A6	0,37	900	0,66	1,3	2,6	3,5	0,00223	20	18000	180	180	14,5
F80B6	0,55	900	0,68	1,8	2,6	3,5	0,00280	20	18000	180	180	16
F90SA6	0,75	910	0,68	2,3	2,2	3,3	0,00356	40	18000	250	250	21
F90LA6	1,10	910	0,68	3,3	2,3	3,7	0,00472	40	14000	250	250	23
F100LA6	1,50	930	0,71	3,9	2,4	4,3	0,00874	48	9000	250	250	28
F100LB6*	1,85	920	0,68	5,0	2,6	4,3	0,00996	48	8500	250	250	32
F112MB6	2,20	940	0,78	5,2	2,3	5,3	0,01680	80	4500	500	550	47
F132SB6	3,00	960	0,76	7,0	2,1	5,6	0,03100	150	3000	800	600	84,5
F132MA6	4,00	960	0,76	9,1	2,7	5,6	0,04250	150	3000	800	600	94,5
F132MB6	5,50	960	0,78	12	2,1	5,5	0,05150	150	2800	800	600	100
F160MB6	7,50	950	0,79	18	2,1	5,6	0,09700	175	900	800	600	130
F160LA6*	9,50	950	0,80	22	2,0	5,5	0,1230	175	900	800	600	150
F160LB6	11,00	960	0,80	26	2,0	5,5	0,1433	175	900	800	600	175
F180LB6	15,00	970	0,81	30	2,1	7,0	0,2180	300	580	800	600	210
F200LA6	18,50	970	0,81	37	2,1	7,0	0,2200	300	330	800	600	230
F200LB6	22,00	970	0,83	43	2,1	7,0	0,2550	300	330	800	600	250

*non unified powers

- 1) Motors from frame 71 to 132 are supplied with voltage at 220/380/50 240/415/50 255/440/60 277/480/60
- 2) Motors frame 160, 180, 200, are supplied as series with motor at V.400/690/50 and electromagnet at V.230/400/50
- 3) The braking torque values can be reduced of about 10% if the electromagnet is DC.

Three phase 8 poles - 750 r.p.m.

Type	kW	r.p.m.	Cos. φ	I n V.400	Ma/Mn	I.A/I.N	Inertia moment Jx Kgm ²	Braking Torque MAX Nm.	Starts C/h	A.V.400 Brake A.C. (m A)	A. V.230AC brake D.C. (m A)	KG.
F71B8	0,12	660	0,55	0,9	2,0	2,7	0,00123	15	22000	110	90	10,5
F80A8	0,18	670	0,59	1,0	1,8	3,2	0,00223	20	20000	180	190	15
F80B8	0,25	670	0,64	1,3	1,7	3,0	0,00280	20	19000	180	190	15,5
F90SA8	0,37	690	0,56	1,6	2,2	2,8	0,00356	40	20000	250	250	20
F90LA8	0,55	690	0,57	2,3	2,2	2,9	0,00472	40	18000	250	250	22
F100LA8	0,75	700	0,59	2,8	2,3	3,2	0,00874	48	12000	250	250	28
F100LB8	1,10	700	0,60	3,6	2,1	3,5	0,00996	48	10000	250	250	32
F112MB8	1,50	710	0,65	4,5	1,9	4,0	0,01680	80	5000	500	550	46
F132SB8	2,20	715	0,72	5,3	1,7	4,8	0,03100	150	3200	800	600	85
F132MA8	3,00	720	0,69	8,5	1,8	4,8	0,04250	150	3000	800	600	93,5
F160MA8	4,00	710	0,71	11	2,0	5,0	0,09500	175	1200	800	600	120
F160MB8	5,50	710	0,73	13	2,0	5,0	0,12300	175	1100	800	600	130
F160LA8	7,50	710	0,71	18	2,2	5,0	0,11800	175	1000	800	600	150
F180LB8	11,0	730	0,75	24	2,0	6,0	0,22000	300	750	800	600	210
F200LA8	15,0	730	0,76	33	1,8	6,5	0,25200	300	450	800	600	250

- 1) Motors from frame 71 to 132 are supplied with voltage at 220/380/50 240/415/50 255/440/60 277/480/60
- 2) Motors frame 160, 180, 200, are supplied as series with motor at V.400/690/50 and electromagnet at V.230/400/50
- 3) The braking torque values can be reduced of about 10% if the electromagnet is DC.

Three phase 2/4 poles - 3000/1500 r.p.m.

Type	kW	r.p.m.	Cos. ϕ	I n V.400	Ma/Mn	I.A/I.N	Inertia moment J_x Kg m^2	Braking Torque MAX Nm.	Starts C/h	A.V.400 Brake A.C. (m A)	A. V.230AC brake D.C. (m A)	KG.
FD71A2/4	0,26 0,18	2800 1380	0,73 0,68	0,8 0,7	2,5 2,4	4,6 3,9	0,00082	15	7000 12000	110	90	10,3
FD71B2/4	0,37 0,26	2800 1390	0,85 0,78	0,90 0,90	2,4 2,3	4,7 3,0	0,00098	15	6000 10000	110	90	11
FD71C2/4	0,45 0,30	2800 1390	0,76 0,70	1,4 1,1	2,6 2,3	4,7 3,9	0,00146	15	5500 9000	110	90	11,5
FD80A2/4	0,65 0,45	2800 1400	0,77 0,72	1,8 1,4	2,3 2,2	5,0 4,8	0,00173	20	3000 10000	180	190	15
FD80B2/4	0,9 0,6	2800 1415	0,78 0,73	2,3 1,8	2,4 2,3	5,1 5,0	0,00290	20	2500 8000	180	190	15,5
FD90SB2/4	1,3 0,9	2800 1420	0,85 0,73	3,3 2,4	2,3 2,3	4,7 4,5	0,00305	40	2000 7500	250	250	20
FD90LA2/4	1,8 1,2	2800 1420	0,81 0,71	4,5 3,2	2,7 2,9	4,9 4,8	0,00388	40	2000 7000	250	250	22
FD90LB2/4	2,2 1,5	2800 1400	0,80 0,74	5,5 3,9	2,7 3,0	4,9 4,6	0,00572	40	1800 7000	250	250	24
FD100LA2/4	2,5 1,9	2860 1420	0,85 0,82	5,2 3,9	2,6 2,4	6,2 5,4	0,00612	48	1000 5500	250	250	28
FD100LB2/4	3,3 2,4	2870 1420	0,85 0,77	7,0 5,3	2,8 2,5	7,0 6,3	0,01180	48	1000 5000	250	250	32
FD112MB2/4	4,5 3,3	2880 1410	0,87 0,86	9,3 6,9	2,4 2,3	7,0 6,3	0,03120	80	500 2000	500	550	48
FD132SB2/4	5,1 4,5	2810 1400	0,91 0,81	11 10	2,7 2,5	5,1 5,8	0,04000	150	450 1500	800	600	84,5
FD132MA2/4	6,0 5,0	2810 1400	0,93 0,80	12,5 12,0	3,0 2,8	5,2 5,8	0,05900	150	400 1000	800	600	94,5
FD160MA2/4	9,50 8,0	2800 1410	0,86 0,85	17 15	2,8 2,3	8,5 5,8	0,06260	175	200 400	800	600	120
FD160MB2/4	11 9,0	2830 1410	0,86 0,86	24 20	2,4 2,3	8,5 5,6	0,08960	175	200 350	800	600	130
FD160LA2/4	13 11	2830 1450	0,86 0,84	27 22	2,5 2,2	8,8 5,5	0,16700	175	150 300	800	600	150
FD180LA2/4	17 14	2830 1420	0,90 0,87	36 29	2,2 2,0	6,0 6,0	0,19900	300	100 300	800	600	210
FD180LB2/4	20 17	2830 1420	0,90 0,87	41 34	2,2 2,0	6,5 6,0	0,12130	300	100 300	800	600	230
FD200LB2/4	28 24	2900 1450	0,90 0,87	58 50	2,2 2,0	6,5 3,0		300	70 200	800	600	250

3) The braking torque values can be reduced of about 10% if the electromagnet is DC.

Type	kW	r.p.m.	Cos. φ	I n V.400	Ma/Mn	I.A/I.N	Inertia moment Jx Kgm ²	Braking Torque MAX Nm.	Starts C/h	A.V.400 Brake A.C. (m A)	A. V.230AC brake D.C. (m A)	KG.
FDA71B2/6	0,25 0,08	2850 930	0,75 0,65	0,95 0,75	2,4 2	4,5 2,4	0,00082	15	3800 12000	110	90	10,5
FDA71C2/6	0,35 0,10	2860 950	0,73 0,66	1,1 1,0	2,3 2,1	5,0 3,4	0,00098	15	3600 11000	110	90	11,2
FDA80A2/6	0,37 0,12	2860 930	0,66 0,58	1,4 0,9	2,5 2,1	4,9 3,3	0,00146	20	2000 10000	180	190	14
FDA80B2/6	0,55 0,18	2860 940	0,67 0,56	1,9 1,2	2,3 2,1	5,2 3,3	0,00173	20	2000 10000	180	190	15,5
FDA90SA2/6	0,90 0,30	2870 940	0,84 0,64	2,1 1,2	2,6 2,2	6,5 2,5	0,00284	40	1900 9000	250	250	20
FDA90LA2/6	1,20 0,40	2870 950	0,81 0,66	2,9 1,7	2,3 2,0	6,3 3,5	0,00305	40	1800 8000	250	250	22
FDA100LB2/6	2,20 0,80	2800 910	0,85 0,64	4,9 2,6	2,7 2,2	6,7 3,5	0,00612	48	900 6000	250	250	32
FDA112MB2/6	3,00 1,00	2880 930	0,85 0,62	6,60 3,50	2,9 2,3	7,1 4,0	0,01180	80	500 4000	500	550	48
FDA132SB2/6	4,00 1,50	2860 920	0,84 0,58	9,5 4,3	2,6 2,1	8,6 5,1	0,03120	150	350 1600	800	600	85
FDA132MB2/6	6,45 2,20	2860 910	0,82 0,60	15,0 7,5	2,7 2,1	8,3 5,5	0,04620	150	350 1600	800	600	102
FDA160LA2/6	11,00 3,40	2860 960	0,84 0,58	20,0 12,0	2,7 2,2	7,1 4,2	0,08960	175	250 900	800	600	150
FDA180LB2/6	16,00 6,50	2800 950	0,79 0,67	39 22	2,3 3,0	7,0 5,3	0,11560	300	90 230	800	600	253

3) The braking torque values can be reduced of about 10% if the electromagnet is DC.

Three phase 2/8 poles - 3000/750 r.p.m.

Type	kW	r.p.m.	Cos. φ	I n V.400	Ma/Mn	I.A/I.N	Inertia moment Jx Kgm ²	Braking Torque MAX Nm.	Starts C/h	A.V.400 Brake A.C. (m A)	A. V.230AC brake D.C. (m A)	KG.
FDA71B2/8	0,25 0,06	2800 690	0,71 0,60	0,95 0,6	2,4 1,9	4,5 2,3	0,00082	15	3600 15000	110	90	10,5
FDA71C2/8	0,35 0,07	2800 690	0,71 0,60	1,3 0,7	2,3 1,9	5,0 2,2	0,00098	15	3600 15000	110	90	11,5
FDA80A2/8	0,37 0,09	2800 690	0,66 0,53	1,4 0,75	2,5 1,9	4,4 2,3	0,00146	20	2000 12000	180	190	14
FDA80B2/8	0,55 0,12	2800 690	0,69 0,53	1,9 0,9	2,3 2	5,2 5,4	0,00173	20	2000 12000	180	190	15,5
FDA90SB2/8	0,75 0,18	2820 700	0,70 0,54	2,1 1,1	2,6 1,9	5,5 2,3	0,00295	40	1900 10000	250	190	20
FDA90LA2/8	1,10 0,30	2820 700	0,75 0,55	2,7 1,5	2,5 1,9	5,6 2,4	0,00305	40	1800 10000	250	250	22
FDA90LB2/8	1,30 0,30	2820 700	0,78 0,58	3,1 1,8	2,4 2	5,8 2,3	0,00388	40	1800 9000	250	250	24
FDA100LA2/8	1,50 0,37	2820 700	0,78 0,56	3,9 2,2	2,6 1,8	5,6 2,8	0,00572	48	1000 7000	250	250	28
FDA100LB2/8	2,20 0,50	2840 700	0,87 0,58	4,9 2,8	2,5 1,8	5,1 2,9	0,00612	48	900 3000	250	250	32
FDA112MA2/8	2,50 0,60	2840 705	0,74 0,57	5,8 3,2	2,4 1,9	5,5 3,0	0,00950	80	500 2500	500	550	45
FDA112MB2/8	3,00 0,80	2850 705	0,74 0,59	6,7 3,6	2,5 2	6,0 3,0	0,01180	80	500 2500	500	550	47
FDA132SB2/8	4,00 1,10	2860 700	0,74 0,60	10,0 4,0	2,6 1,9	6,5 2,9	0,03120	150	300 1500	800	600	84,5
FDA132MA2/8	5,50 1,50	2870 700	0,75 0,61	12,0 5,6	2,5 2,1	6,6 3,0	0,04000	150	300 1300	800	600	94,5
FDA132MB2/8	6,20 1,80	2860 690	0,82 0,67	13,7 6,8	2,5 2,1	6,6 3,0	0,04620	150	300 1300	800	600	100
FDA160LA2/8	11,00 3,00	2900 720	0,90 0,63	24,0 14,0	2,4 2,2	6,8 3,4	0,08960	175	300 1300	800	600	150

3) The braking torque values can be reduced of about 10% if the electromagnet is DC.

Three phase 4/6 poles 1500/1000 r.p.m.

Type	kW	r.p.m.	Cos. φ	I n V.400	Ma/Mn	I.A/I.N	Inertia moment Jx Kg ^m ²	Braking Torque MAX Nm.	Starts C/h	A.V.400 Brake A.C. (m A)	A. V.230AC brake D.C. (m A)	KG.
FDA71A4/6	0,13 0,08	1360 890	0,70 0,64	0,7 0,4	2,3 2,0	4,5 3	0,00091	15	7000 10000	110	90	10,5
FDA71B4/6	0,18 0,11	1370 900	0,72 0,67	0,7 0,5	2,3 2,2	4,5 2,9	0,00123	15	7000 10000	110	90	11,5
FDA80A4/6	0,26 0,18	1390 930	0,75 0,68	1,0 0,9	2,4 2,0	4,8 3	0,00223	20	7000 10000	180	190	14
FDA80B4/6	0,37 0,26	1400 930	0,76 0,69	1,1 1,0	2,5 2,0	4,8 3	0,00280	20	6000 8000	180	190	15,5
FDA90SA4/6	0,55 0,37	1410 945	0,77 0,70	1,8 1,6	2,4 2,1	5,5 3,6	0,00356	40	6000 8000	250	250	20
FDA90LA4/6	0,75 0,55	1410 945	0,79 0,60	2,4 2	2,3 2,2	5,6 3,3	0,00472	40	9500 8000	250	250	22
FDA100LB4/6	1,50 1,10	1420 945	0,79 0,70	3,9 3,2	2,6 2,3	5,6 3,5	0,00996	48	4000 6000	250	250	32
FDA112MB4/6	2,00 1,30	1430 950	0,86 0,71	4,5 3,6	2,4 2,0	5,3 4,5	0,01680	80	2000 3000	500	550	48,0
FDA132SB4/6	2,20 1,50	1430 930	0,84 0,71	5,0 3,7	2,3 1,9	6 3,4	0,03100	150	600 1000	800	600	84,5
FDA132MA4/6	3,00 2,20	1430 930	0,84 0,72	6,0 5,2	2,4 2,2	6,0 3,6	0,04250	150	800 1200	800	600	94,5
FDA132MB4/6	3,70 2,60	1440 930	0,84 0,72	8,3 6,2	2,3 2,2	6,1 3,8	0,04950	150	700 1000	800	600	100
FDA160MB4/6	5,50 3,70	1450 930	0,85 0,75	12 8,5	2,2 2,0	7 4	0,10700	175	500 700	800	600	130
FDA160LB4/6	7,50 5,50	1450 930	0,84 0,76	17,5 13,5	2,3 2,0	7 4	0,14350	175	400 700	800	600	170
FDA180LA4/6	11,0 7,5	1450 930	0,88 0,70	22 18,5	2,1 2,0	7 5	0,1860	300	250 400	800	600	200
FDA180LB4/6	13 8,8	1450 930	0,88 0,70	27 22	2,2 2,0	7 5	0,2180	300	230 380	800	600	210
FDA200LB4/6	18,5 12,5	1460 970	0,84 0,76	35 25	2,0 2,0	7 6	0,25500	300	120 180	800	600	250

3) The braking torque values can be reduced of about 10% if the electromagnet is DC.

Three phase 4/8 poles - 1500/750 r.p.m.

Type	kW	r.p.m.	Cos. φ	I n V.400	Ma/Mn	I.A/I.N	Inertia moment Jx Kgm ²	Braking Torque MAX Nm.	Starts C/h	A.V.400 Brake A.C. (m A)	A. V.230AC brake D.C. (m A)	KG.
FD71A4/8	0,13 0,07	1360 680	0,83 0,62	0,5 0,5	2,0 2,2	3,7 2,5	0,00091	15	12000 20000	110	90	10
FD71B4/8	0,18 0,09	1360 680	0,82 0,63	0,7 0,7	2,2 1,9	3,8 2,6	0,00123	15	10000 20000	110	90	10,5
FD71C4/8	0,22 0,12	1360 670	0,80 0,60	0,8 0,8	2,1 1,9	3,9 2,7	0,00141	15	9000 20000	110	90	12
FD80A4/8	0,26 0,18	1410 6750	0,83 0,60	0,9 0,9	2,2 1,9	5,5 3,0	0,00223	20	7000 14000	180	190	14,5
FD80B4/8	0,37 0,26	1405 675	0,84 0,64	0,9 1,2	2,3 2,0	5,5 2,8	0,00280	20	7000 14000	180	190	15,5
FD90SA4/8	0,75 0,37	1400 700	0,85 0,60	2,1 1,9	1,9 2,2	4,0 3,0	0,00356	40	6500 12000	250	250	20
FD90LB4/8	1,10 0,60	1400 700	0,85 0,58	2,7 3,0	2,0 2,2	4,0 3,0	0,00510	40	6000 10000	250	250	24
FD100LB4/8	1,60 0,90	1440 700	0,85 0,61	3,7 3,5	2,2 2,2	4,6 3,2	0,00996	48	4000 8000	250	250	32
FD112MB4/8	2,20 1,20	1440 710	0,89 0,59	4,6 4,8	2,2 3,0	5,6 4,0	0,01680	80	2000 4000	500	550	48
FD132SB4/8	3,00 2,00	1430 715	0,88 0,59	6,1 6,9	2,7 2,5	5,5 3,5	0,03100	150	700 2000	800	600	84,5
FD132MA4/8	4,00 2,60	1445 720	0,87 0,63	8,0 8,5	3,0 2,9	5,6 5,5	0,04250	150	500 1500	800	600	98
FD160MA4/8	5,50 3,70	1430 720	0,86 0,64	11,5 12,5	2,5 2,1	5,8 5,3	0,09500	175	600 1200	800	600	120
FD160MB4/8	6,60 4,50	1430 720	0,88 0,65	14,5 13,8	2,3 2,2	5,9 5,3	0,09700	175	600 1200	800	600	130
FD160LA4/8	9,60 6,00	1430 720	0,86 0,66	21 19	2,6 2,1	6,0 5,1	0,12300	175	550 1100	800	600	150
FD180LA4/8	11 8	1460 730	0,85 0,68	22 22	2,2 2,0	6,0 5,0	0,1860	300	400 700	800	600	190
FD180LB4/8	14 10	1450 720	0,87 0,72	28 25	2,2 2,0	6,0 4,5	0,2180	300	400 680	800	600	230
FD200LB4/8	21 13	1460 730	0,87 0,75	41 30	2,0 2,0	6,3 5,0	0,2550	300	80 240	800	600	250

3) The braking torque values can be reduced of about 10% if the electromagnet is DC.

*Three phase 4-12 poles - 1500/500 r.p.m.
hoisting application*

Type	kW S3 40%-25%	I n V.400	Type	kW S3 40%-25%	I n V.400
FDA71C4/12	0,20 0,08	1,20 0,80	FDA112MC4/12	4,50 1,50	11,0 7,00
FDA80C4/12	0,55 0,18	1,70 1,20	FDA132MB4/12	6,10 1,75	13,6 9,70
FDA90LB4/12	0,80 0,30	2,50 2,20	FDA132MC4/12	7,70 2,50	17,0 11,5
FDA100LB4/12	1,70 0,60	3,40 2,90	FDA160LB4/12	14,0 4,80	30,0 24,0
FDA112MB4/12	3,20 1,10	8,00 6,00	FDA160LC4/12	16,5 5,15	33,0 29,0

*Three phase 4-16 poles - 1500/375 r.p.m.
hoisting application*

Type	kW S3 40%-20%	I n V.400
FDA112MB4/16	1,6 0,4	4,6 3,8
FDA132SA4/16	2,80 0,70	6,5 4,8
FDA132MA4/16	4,00 1,00	8,8 7,2
FDA132MB4/16	5,5 1,3	13,8 12,0
FDA160MB4/16	6,80 1,70	18,0 15,0
FDA160LA4/16	9,00 2,20	23,0 21,0
FDA160LB4/16	10,5 2,60	24,0 22,0
FDA180LB4/16	13,0 3,20	32,5 17,8
FDA200LB4/16	16,0 4,00	41,0 22,0

Overall dimensions

B3

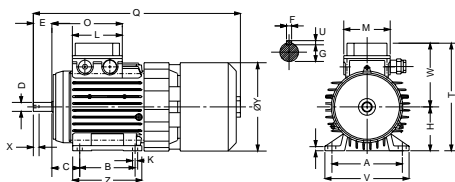

Type	A	B	C	D	E	F	G	H	K	L	M	Q	T	O	W	Y	U	X	V	Z	I
F 71	112	90	45	14	30	5	11	71	7	81	75	335	173	148	102	141	5	M5	134	108	7
F 80	125	100	50	19	40	6	15,5	80	7	81	75	370	194	162	114	157	6	M6	156	126	8
F 90 S	140	100	56	24	50	8	20	90	9	98	99	415	218	174	128	179	7	M8	176	128	10
F 90 L	140	125	56	24	50	8	20	90	9	98	99	440	218	195	128	179	7	M8	176	151	10
F 100	160	140	63	28	60	8	24	100	9	98	99	491	241	218	141	179	7	M8	196	166	10
F 112	190	140	70	28	60	8	24	112	12	98	99	530	263	235	151	220	7	M8	230	166	15
F 132 S	216	140	89	38	80	10	33,5	132	12	120	110	618	329	257	197	255	8	M10	262	166	16
F 132 M	216	178	89	38	80	10	33,5	132	12	120	110	658	329	297	197	255	8	M10	262	205	16
F 160 M	254	210	108	42	110	12	37,5	160	14	180	180	771	386	331	226	314	8	M12	306	240	22
F 160 L	254	254	108	42	110	12	37,5	160	14	180	180	811	386	420	226	314	8	M12	306	284	22
F180M	279	241	121	48	110	14	42,5	180	15	200	200	900	455	220	275	314	9	M16	355	300	22
F180L	279	279	121	48	110	14	42,5	180	15	200	200	910	455	220	275	314	9	M16	355	300	22
F200L	318	305	133	55	110	16	49	200	19	230	230	950	545	240	345	314	10	M16	395	320	26

B5

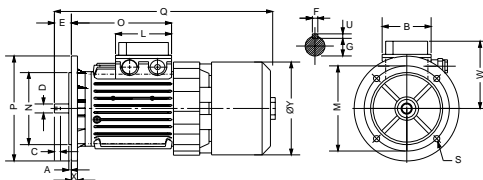

Type	N	B	C	D	E	F	G	H	P	I	L	M	O	Q	S	U	A	X	W	Y
F 71	110	75	M5	14	30	5	11	-	160	-	81	130	148	335	9,5	5	3,5	10	102	141
F 80	130	75	M6	19	40	6	15,5	-	200	-	81	165	162	370	11,5	6	3,5	12	114	157
F 90 S	130	99	M8	24	50	8	20	-	200	-	98	165	182	415	11,5	7	3,5	12	128	179
F 90 L	130	99	M8	24	50	8	20	-	200	-	98	165	195	440	11,5	7	3,5	12	128	179
F 100	180	99	M8	28	60	8	24	-	250	-	98	215	218	483	14	7	3,5	14	141	179
F 112	180	99	M8	28	60	8	24	-	250	-	98	215	235	519	14	7	3,5	14	151	222
F 132 S	230	110	M10	38	80	10	33,5	-	300	-	120	265	260	618	14	8	3,5	14	197	255
F 132 M	230	110	M10	38	80	10	33,5	-	300	-	120	265	300	658	14	8	3,5	14	197	255
F 160 M	250	180	M12	42	110	12	37,5	-	350	-	180	300	330	771	18	8	4	16	226	314
F 160 L	250	180	M12	42	110	12	37,5	-	350	-	180	300	420	811	18	8	4	16	226	314
F180M	250	200	M16	48	110	14	42,5	-	350	-	200	300	220	900	18	9	5	16	275	314
F180L	250	200	M16	48	110	14	42,5	-	350	-	200	300	220	910	18	9	5	16	275	314
F200L	300	210	M16	55	110	16	49	-	400	-	210	350	240	950	18	10	5	18	345	314

B14

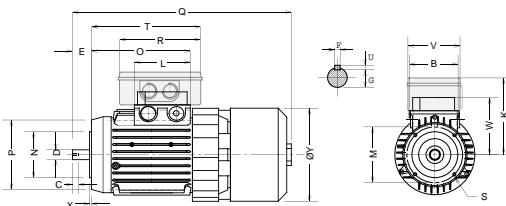

Type	N	B	C	D	E	F	G	H	P	I	L	M	O	Q	S	U	X	Z	W	Y	T	R	V	K
F 71	70	75	M5	14	30	5	11	-	105	-	81	85	148	335	M6	5	3,5	-	102	141	172	128	83	107
F 80	80	75	M6	19	40	6	15,5	-	120	-	81	100	162	370	M6	6	3,5	-	114	157	185,5	128	83	116
F 90 S	95	99	M8	24	50	8	20	-	140	-	98	115	171	415	M8	7	3,5	-	128	179	202	160	107	131
F 90 L	95	99	M8	24	50	8	20	-	140	-	98	115	195	440	M8	7	3,5	-	128	179	227	160	107	131
F 100	110	99	M8	28	60	8	24	-	160	-	98	130	218	480	M8	7	3,5	-	141	180	249	160	107	141
F 112	110	99	M8	28	60	8	24	-	160	-	98	130	235	519	M8	7	3,5	-	151	222	265	160	107	151
F 132 S	130	110	M10	38	80	10	33,5	-	200	-	120	165	260	618	M10	8	3,5	-	197	263	---	---	---	---
F 132 M	130	110	M10	38	80	10	33,5	-	200	-	120	165	300	658	M10	8	3,5	-	197	263	---	---	---	---

Brake motors with forced ventilation F series

F series motors can be fitted with forced ventilation. The auxiliary ventilation is “in line” for frame 71 to 160 and lateral for 180-200 ; this solution, guarantees an efficient cooling of the motor even in the most extreme conditions thanks to the high volume of the air supplied by the auxiliary fans.

The auxiliary fan is especially recommended for motors driven by frequency inverters, or for very hard duty cycles.

The length of motors (“Q” quote on overall dimensions F series), will change as following:

Type	Q	Type	Q
71	350	112	540
80	411	132S	660
90S	455	132L	705
90L	480	160S	825
100	525	160L	870



Characteristics of auxiliary fans

Type	V	Hz	m ³ /h (efficiency)	rpm	W	A
71	230 -1ph	50	160	2650	20	0,12
		60	180	3000	18	0,11
80	230 -1ph	50	360	2800	26	0,13
		60	400	3300	26	0,12
90	230 -1ph	50	360	2800	26	0,13
		60	400	3300	26	0,12
100	230 -1ph	50	360	2800	26	0,13
		60	400	3300	26	0,12
112	230 -1ph	50	810	2740	50	0,24
		60	920	3120	61	0,27
132	230 -1ph	50	910	2600	63	0,30
		60	1050	2900	70	0,32
160	230 -1ph	50	1815	2500	120	0,53
		60	1865	2600	160	0,70
180 - 200	400 -3ph	50	600	2700	180	0,70
		60	600	3200	180	0,70

FK series
asynchronous brake motors

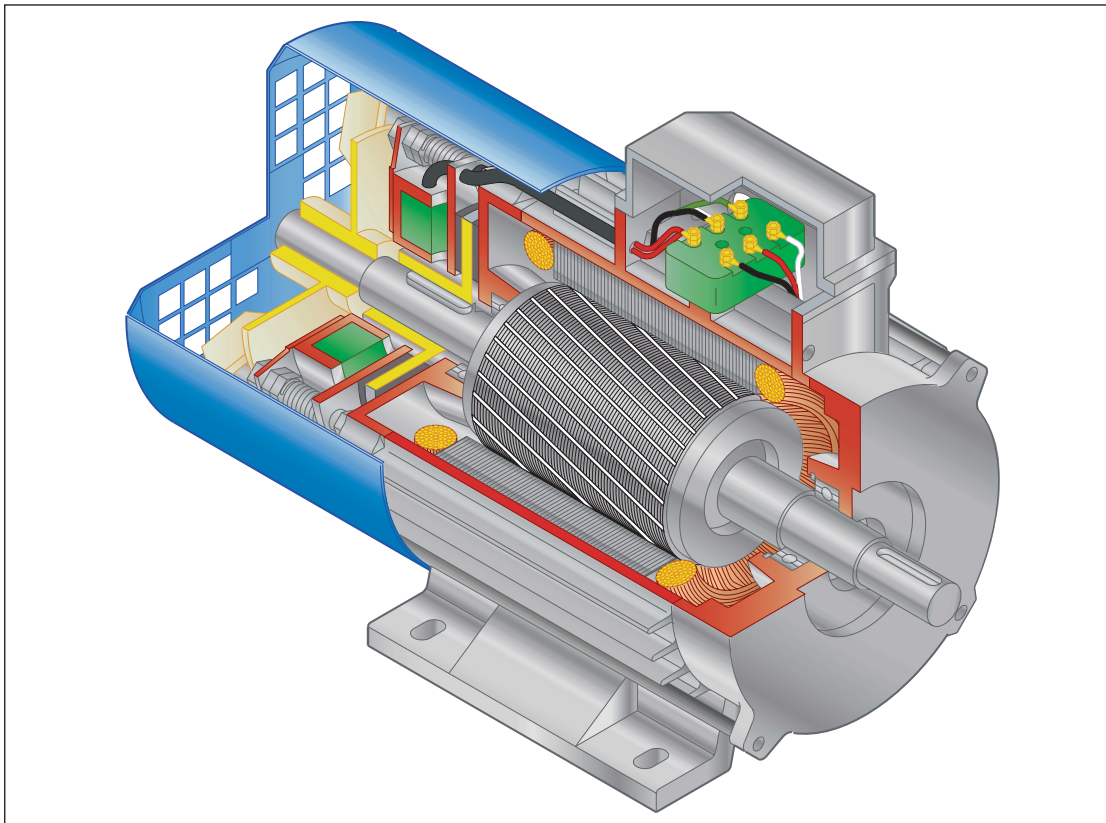

FK motors are fitted with DC brake as standard. The motor operates with very low noise and it's suitable also for inverter duty.

Use of the FK series motors for those applications which do not require high braking torque values, but for which reliability of a safe braking group is anyhow necessary.

Characteristics

- Brake disk without axial movement of the shaft
- Adjustable braking torque
- Operation of the brake within very low values of noise and amperage
- Smaller size compared to the F series
- The FK - FKL series are fitted with DC electromagnets

FK - FKL series

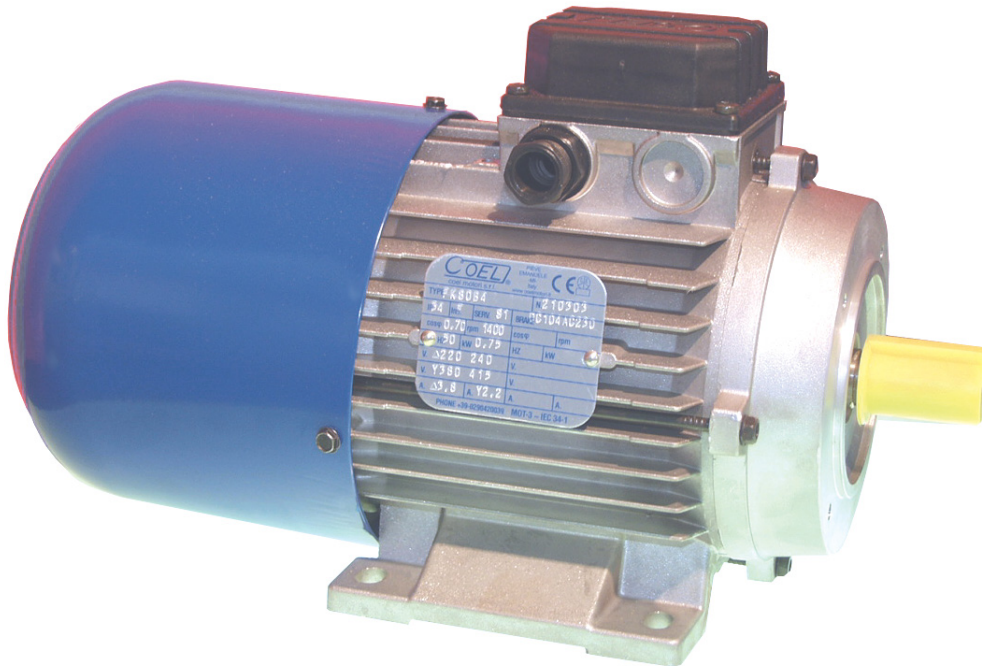

FKL series with progressive start up and braking

Besides the FK series motor, which ensures itself a smooth start-up and braking, FKL series are fitted with flywheel to make the start and braking gradual.

The progressive starting is obtained adjusting the maximum torque in relation to the start-up torque and applying an additional weight, precisely calculated, to the rear end of the motor shaft that slows down the start-up times, allowing, in any case to achieve maximum torque values and a gradual slowing down as the motor brakes.

The FKL motor is particularly suitable for cranes travelling, bottling machines and all those applications where lack of noise, gradual start-up and braking are indispensable requirements.

Possible product configurations

- Motors with feet (B3)
- Motors with feet and flange
- Motors with flange B5 and B14
- Motors with reduced B5 flange form frame 71 to 160
- Motors with reduced B14 flange from frame 71 to 100
- Double shafts
- Special shafts
- Motors B3 with lateral terminal box
- Custom motors
- Special windings
- Auxiliary fan version (same length than standard)
- Separate brake supply
- H class insulation
- IP protection higher than standard
- Special "P" rotor
- Special painting
- Thermal protections
- Anti condense resistor
- R or S type equilibration of the rotor
- Motors with encoder
- Lateral brake release
- FKL series
- FKP series with positive brake
- KK series with patented brake release system

Description of spare parts
FK/FKL series

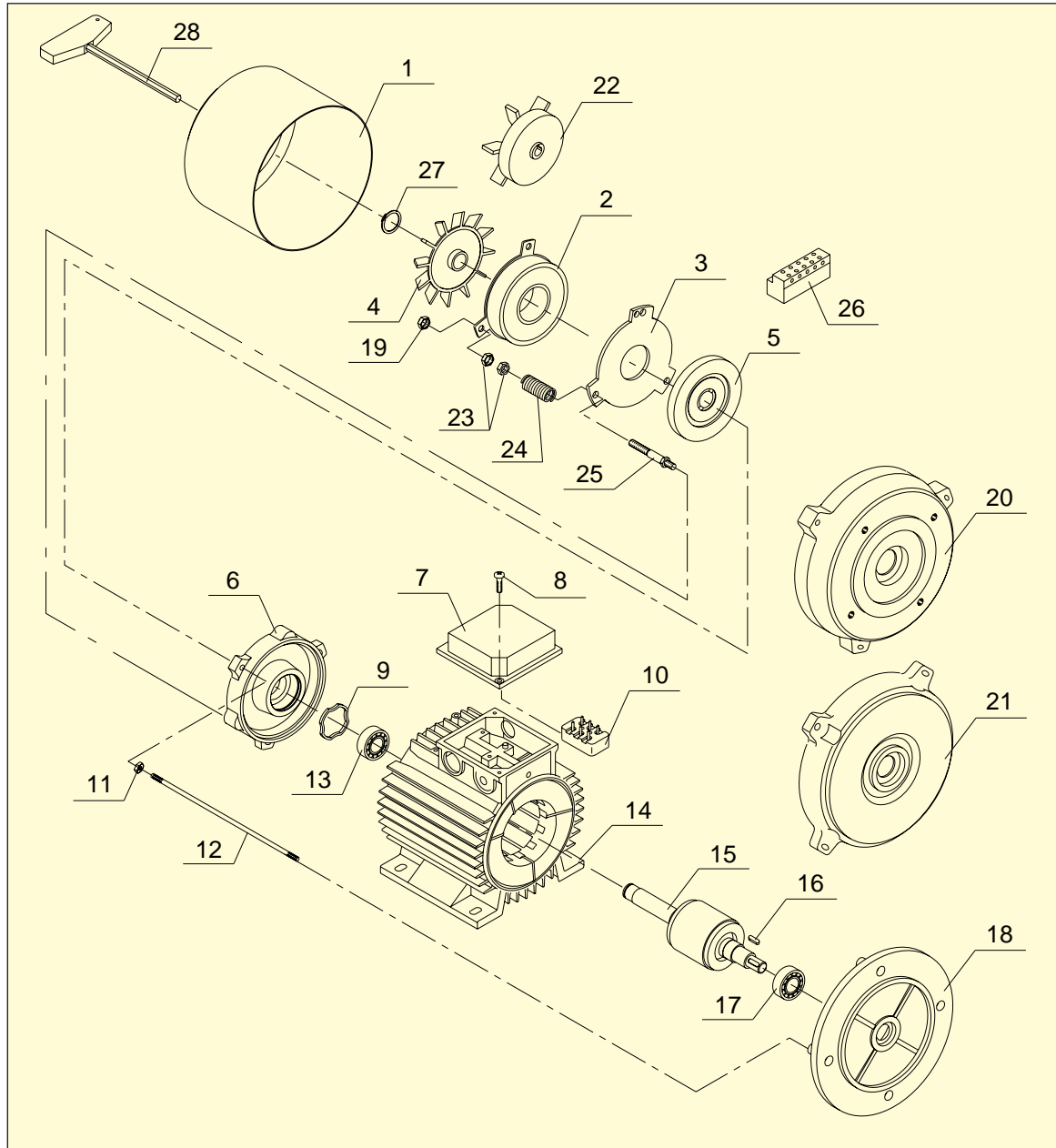

1 Brake cover	15 Rotor - shaft group
2 Electromagnet	16 Key
3 Mobil anchor	17 Front bearing
4 Fan	18 B5 flange
5 Brake disk	19 Electromagnet locking nuts
6 Back flange with friction trak	20 B14 flange
7 Terminal box cover	21 B3 shield
8 Drawrod for terminal box cover	22 Heavy fan
9 Compensation ring	23 Adjustment nuts
10 Terminal board	24 Brake spring
11 Drawrod locking nut	25 Guide drawrods
12 Drawrod	26 Rectifier
13 Back side bearing	27 Seeger or locking nut
14 Motor case	28 Manual rotation key

FK brake group

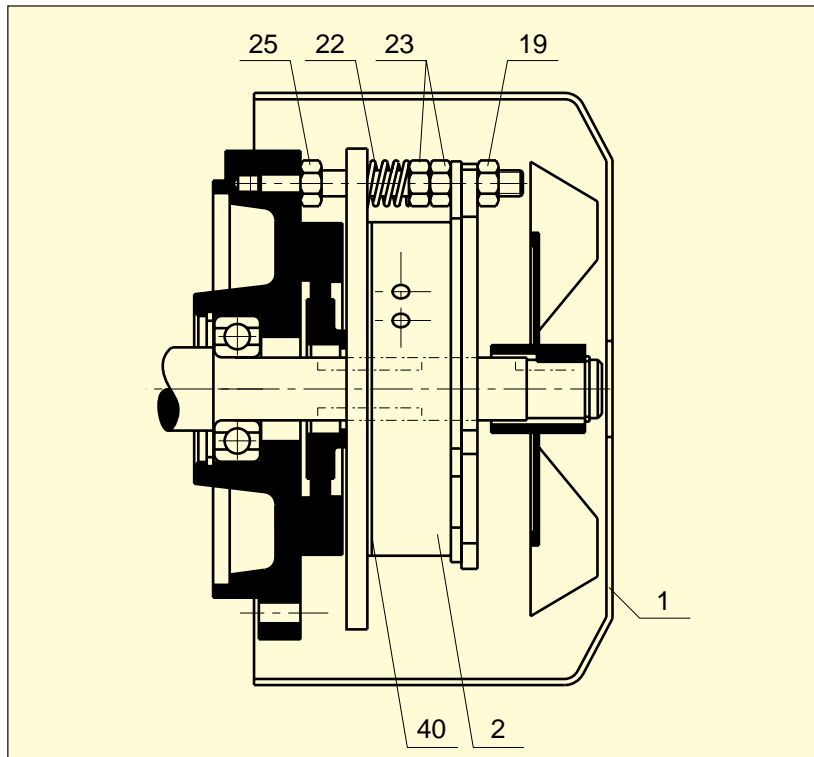

Magnetic gap adjustment

Magnetic gap 40 (the distance between the electromagnet and of the mobile anchor) must be regulated at approximately mm. 0,3.

The magnetic gap should be periodically checked. In order to adjust the magnetic gap, turn the couples of nuts (19) moving the electromagnet to the mobile anchor. When the magnetic gap has been adjusted check that nuts have been correctly locked.

Replacing the electromagnet

Remove cap 1, disconnect the 2 terminals of the magnet, remove the fan, unscrew the three nuts 19 and remove the electromagnet 6.

Put the new electromagnet on to the stud bolts. Adjust the magnetic gap.

Replacing the brake disk

Remove the cap 1 and the fan. Completely disassemble the brake components. Remove the brake disk and apply the new one. Assemble the brake group and adjust the magnetic gap.

Braking torque adjustment

Braking torque is proportional to compression of springs 9; such compression can be modified working on nuts 8 (loosen to decrease, tighten to increase). Compression of the three springs must be uniform.

See the indicative following description to adjust the braking torque values.

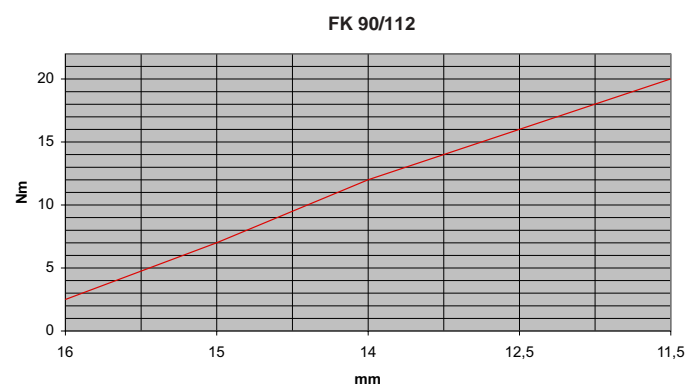
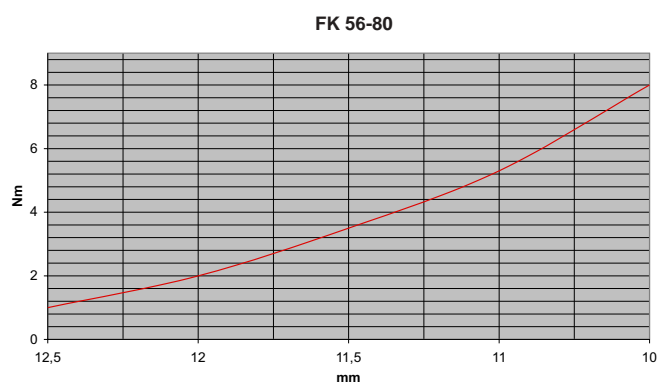

Three phase 2 poles - 3000 r.p.m.

Type	kW	r.p.m.	Cos ϕ	I n V.400	Ma/Mn	I.A/I.N	Inertia moment Jx Kgm ²	Braking torque MAX Nm.	AVV. C/h	In - V.230AC brake D.C. (m A)	Kg.
FK56B2	0,12	2785	0,66	0,45	2,4	2,9	0,00030	8	9500	150	4,2
FK63A2	0,18	2760	0,68	0,70	2,3	3,5	0,00042	8	8000	150	4,8
FK63B2	0,25	2810	0,80	0,80	2,3	3,9	0,00057	8	7500	150	4,8
FK63C2*	0,37	2780	0,78	1,10	2,4	4,0	0,00061	8	6000	150	5
FK71A2	0,37	2765	0,79	1,05	2,5	3,9	0,00071	8	6000	150	7
FK71B2	0,55	2780	0,79	1,50	2,5	3,9	0,00082	8	5000	150	8
FK71C2*	0,75	2800	0,76	2,10	2,3	4,3	0,00098	8	4000	150	9
FK80A2	0,75	2780	0,77	2,00	3,0	4,8	0,00146	8	6000	150	10
FK80B2	1,10	2780	0,82	2,90	3,0	4,9	0,00173	8	5300	150	12,5
FK90SA2	1,50	2780	0,86	3,50	2,5	6,8	0,00189	20	4000	300	18
FK90SB2	1,84	2780	0,86	4,30	2,5	6,8	0,00200	20	3500	300	19
FK90LA2	2,20	2800	0,88	5,10	2,5	6,8	0,00232	20	3000	300	20
FK100LA2	3,00	2800	0,88	6,50	2,9	8,0	0,00572	20**	1200	300	23
FK112MB2	4,00	2820	0,87	8,20	2,4	7,4	0,00720	20**	800	300	40

* Non unified powers

** Nm 40 on request

Three phase 4 poles - 1500 r.p.m.

Type	kW	r.p.m.	COS φ	I n V.400	Ma/Mn	I.A/I.N	Inertia moment Jx Kgm ²	Braking torque MAX Nm.	AVV. C/h	In - V.230AC brake D.C. (m A)	Kg.
FK56B4	0,09	1320	0,60	0,38	1,80	2,6	0,00030	8	12500	150	4,3
FK63A4	0,12	1350	0,70	0,54	1,95	2,8	0,00042	8	12000	150	5,5
FK63B4	0,18	1340	0,70	0,60	1,80	2,3	0,00057	8	12000	150	5,5
FK63C4*	0,23	1330	0,68	0,80	2,20	2,4	0,00061	8	10000	150	5,9
FK71A4	0,25	1400	0,65	0,9	2,70	3,9	0,00071	8	19500	150	9,5
FK71B4	0,37	1390	0,68	1,1	2,70	4,1	0,00082	8	18000	150	10
FK71C4*	0,55	1360	0,72	1,7	2,30	3,1	0,00098	8	15000	150	10,5
FK80A4	0,55	1390	0,68	1,65	2,30	4,0	0,00146	8	10000	150	10
FK80B4	0,75	1400	0,70	2,15	2,60	4,2	0,00173	8	10000	150	12,5
FK80C4*	0,90	1390	0,69	2,7	2,50	4,3	0,00185	8	9000	150	14,5
FK90SA4	1,10	1400	0,77	2,7	2,30	4,6	0,00284	20	10000	300	18
FK90LA4	1,50	1400	0,77	3,7	3,00	4,9	0,00305	20	10000	300	20
FK90LB4*	1,85	1400	0,77	4,3	3,00	4,6	0,00388	20	9000	300	22
FK90LC4*	2,20	1400	0,78	5,4	2,90	4,3	0,00430	20	8000	300	24
FK100LA4	2,20	1410	0,78	5,0	2,70	5,5	0,00572	20**	7500	300	24
FK100LB4	3,00	1410	0,82	6,4	2,70	5,0	0,00612	20**	7000	300	26
FK100LC4*	3,30	1410	0,80	7,5	2,60	4,7	0,00750	20**	6800	300	30
FK112MB4	4,00	1430	0,84	8,2	2,70	5,8	0,01180	20**	3300	300	40

* Non unified powers

** Nm 40 on request

Three phase 6 poles - 1000 r.p.m.

Type	kW	r.p.m.	Cos ϕ	I n V.400	Ma/Mn	I.A/I.N	Inertia moment Jx Kgm ²	Braking torque MAX Nm.	AVV. C/h	In - V.230AC brake D.C. (m A)	Kg.
FK63C6	0,12	900	0,58	0,60	2,0	2,7	0,00072	8	20000	150	5,5
FK71A6	0,18	900	0,69	0,8	1,9	2,5	0,00091	8	22000	150	9,5
FK71B6	0,25	910	0,69	1,0	2,0	2,5	0,00123	8	22000	150	10
FK71C6*	0,30	900	0,68	1,2	1,9	2,6	0,00141	8	19000	150	11
FK80A6	0,37	900	0,66	1,3	2,6	3,5	0,00223	8	18000	150	12
FK80B6	0,55	900	0,68	1,8	2,6	3,5	0,00280	8	18000	150	13
FK90SA6	0,75	910	0,68	2,3	2,2	3,3	0,00356	20	18000	300	16
FK90LA6	1,10	910	0,68	3,3	2,3	3,7	0,00472	20	14000	300	19
FK100LA6	1,50	930	0,71	3,9	2,4	4,3	0,00874	20**	9000	300	27
FK100LB6*	1,85	920	0,68	5,0	2,6	4,3	0,00996	20**	8500	300	30
FK112MB6	2,20	940	0,78	5,2	2,3	5,3	0,01680	20**	4500	300	43

* Non unified powers

** Nm 40 on request

Three phase 8 poles - 750 r.p.m.

Type	kW	r.p.m.	Cos φ	I n V.400	Ma/Mn	I.A/I.N	Inertia moment Jx Kgm ²	Braking torque MAX Nm.	AVV. C/h	In - V.230AC brake D.C. (m A)	Kg.
FK63C8	0,07	650	0,53	0,65	2,3	1,7	0,00072	8	20000	150	5,1
FK71B8	0,12	660	0,55	0,9	2,0	2,7	0,00123	8	22000	150	8
FK80A8	0,18	670	0,59	1,0	1,8	3,2	0,00223	8	20000	150	12
FK80B8	0,25	670	0,64	1,3	1,7	3,0	0,00280	8	19000	150	13
FK90SA8	0,37	690	0,56	1,6	2,2	2,8	0,00356	20	20000	300	16
FK90LA8	0,55	690	0,57	2,3	2,2	2,9	0,00472	20	18000	300	22
FK100LA8	0,75	700	0,59	2,8	2,3	3,2	0,00874	20**	12000	300	27
FK100LB8	1,10	700	0,60	3,6	2,1	3,5	0,00996	20**	10000	300	30
FK112MB8	1,50	710	0,65	4,5	1,9	4,0	0,01680	20**	5000	300	43

** Nm 40 on request

Three phase 2/4 poles - 3000/1500 r.p.m.

Type	kW	r.p.m.	Cos φ	I n V.400	Ma/Mn	I.A/I.N	Inertia moment Jx Kgm ²	Braking torque MAX Nm.	AVV. C/h	In - V.400AC brake D.C. (m A)	Kg.
FKD63B2/4	0,23	2800	0,75	0,75	2,9	4,1	0,00057	8	5000	90	5,5
	0,15	1330	0,65	0,70	3,0	3,2			6500		
FKD63C2/4	0,26	2800	0,72	0,95	3,0	4,6	0,00061	8	4500	90	5,1
	0,17	1330	0,56	0,85	3,0	3,3			6000		
FKD71A2/4	0,26	2800	0,73	0,8	2,5	4,6	0,00071	8	7000	90	9,5
	0,18	1380	0,68	0,7	2,4	3,9			12000		
FKD71B2/4	0,37	2800	0,85	0,90	2,4	4,7	0,00082	8	6000	90	10
	0,26	1390	0,78	0,90	2,3	3,0			10000		
FKD71C2/4	0,45	2800	0,76	1,4	2,6	4,7	0,00098	8	5500	90	10,5
	0,30	1390	0,70	1,1	2,3	3,9			9000		
FKD80A2/4	0,65	2800	0,77	1,8	2,3	5,0	0,00146	8	3000	90	11
	0,45	1400	0,72	1,4	2,2	4,8			10000		
FKD80B2/4	0,9	2800	0,78	2,3	2,4	5,1	0,00173	8	2500	90	12,5
	0,6	1415	0,73	1,8	2,3	5,0			8000		
FKD90SB2/4	1,3	2800	0,85	3,3	2,3	4,7	0,00295	20	2000	180	20
	0,9	1420	0,73	2,4	2,3	4,5			7500		
FKD90LA2/4	1,8	2800	0,81	4,5	2,7	4,9	0,00305	20	2000	180	20
	1,2	1420	0,71	3,2	2,9	4,8			7000		
FKD90LB2/4	2,2	2800	0,80	5,5	2,7	4,9	0,00388	20	1800	180	22
	1,5	1400	0,74	3,9	3,0	4,6			7000		
FKD100LA2/4	2,5	2860	0,85	5,2	2,6	6,2	0,00572	20**	1000	180	23
	1,9	1420	0,82	3,9	2,4	5,4			5500		
FKD100LB2/4	3,3	2870	0,85	7,0	2,8	7,0	0,00612	20**	1000	180	26
	2,4	1420	0,77	5,3	2,5	6,3			5000		
FKD112MB2/4	4,5	2880	0,87	9,3	2,4	7,0	0,01180	20**	500	180	40
	3,3	1410	0,86	6,9	2,3	6,3			2000		

Three phase 2/6 poles - 3000/1000 r.p.m.

Type	kW	r.p.m.	Cos ϕ	I n V.400	Ma/Mn	I.A/I.N	Inertia moment Jx Kgm ²	Braking torque MAX Nm.	AVV. C/h	In - V.400AC brake D.C. (m A)	Kg.
FKDA71B2/6	0,25 0,08	2850 930	0,75 0,65	0,95 0,75	2,4 2,0	4,5 2,4	0,00082	8	3800 12000	90	8,5
FKDA71C2/6	0,35 0,10	2860 950	0,73 0,66	1,1 1,0	2,3 2,1	5,0 3,4	0,00098	8	3600 11000	90	9,5
FKDA80A2/6	0,37 0,12	2860 930	0,66 0,58	1,4 0,9	2,5 2,1	4,9 3,3	0,00146	8	2000 10000	90	12
FKDA80B2/6	0,55 0,18	2860 940	0,67 0,56	1,9 1,2	2,3 2,1	5,2 3,3	0,00173	8	2000 10000	90	13
FKDA90SA2/6	0,90 0,30	2870 940	0,84 0,64	2,1 1,2	2,6 2,2	6,5 2,5	0,00284	20	1900 9000	180	17
FKDA90LA2/6	1,20 0,40	2870 950	0,81 0,66	2,9 1,7	2,3 2,0	6,3 3,5	0,00305	20	1800 8000	180	20
FKDA100LB2/6	2,20 0,80	2800 910	0,85 0,64	4,9 2,6	2,7 2,2	6,7 3,5	0,00612	20**	900 6000	180	26
FDA112MB2/6	3,00 1,00	2880 930	0,85 0,62	6,60 3,50	2,9 2,3	7,1 4,0	0,01180	20**	500 4000	180	44

** Nm 40 on request

Three phase 2/8 poles - 3000/750 r.p.m.

Type	kW	r.p.m.	Cos ϕ	I n V.400	Ma/Mn	I.A/I.N	Inertia Jx Kgm ²	Braking torque MAX Nm.	AVV. C/h	In - V.400AC brake D.C. (m A)	Kg.
FKDA63C2/8	0,18 0,04	2690 625	0,80 0,60	0,8 0,5	2,3 1,7	5,0 2,2	0,00061	8	5000 12000	90	5,5
FKDA71B2/8	0,25 0,06	2800 690	0,71 0,60	0,95 0,6	2,4 1,9	4,5 2,3	0,00082	8	3600 15000	90	8,5
FKDA71C2/8	0,35 0,07	2800 690	0,71 0,60	1,3 0,7	2,3 1,9	5,0 2,2	0,00098	8	3600 15000	90	9,5
FKDA80A2/8	0,37 0,09	2800 690	0,66 0,53	1,4 0,75	2,5 1,9	4,4 2,3	0,00146	8	2000 12000	90	12
FKDA80B2/8	0,55 0,12	2800 690	0,69 0,53	1,9 0,9	2,3 2	5,2 5,4	0,00173	8	2000 12000	90	13
FKDA90SB2/8	0,75 0,18	2820 700	0,70 0,54	2,1 1,1	2,6 1,9	5,5 2,3	0,00295	20	1900 10000	180	19
FKDA90LA2/8	1,10 0,30	2820 700	0,75 0,55	2,7 1,5	2,5 1,9	5,6 2,4	0,00305	20	1800 10000	180	20
FKDA90LB2/8	1,30 0,30	2820 700	0,78 0,58	3,1 1,8	2,4 2	5,8 2,3	0,00388	20	1800 9000	180	22
FKDA100LA2/8	1,50 0,37	2820 700	0,78 0,56	3,9 2,2	2,6 1,8	5,6 2,8	0,00572	20**	1000 7000	180	23
FKDA100LB2/8	2,20 0,50	2840 700	0,87 0,58	4,9 2,8	2,5 1,8	5,1 2,9	0,00612	20**	900 3000	180	26
FKDA112MA2/8	2,50 0,60	2840 705	0,74 0,57	5,8 3,2	2,4 1,9	5,5 3,0	0,00950	20**	500 2500	180	38
FKDA112MB2/8	3,00 0,80	2850 705	0,74 0,59	6,7 3,6	2,5 2	6,0 3,0	0,01180	20**	500 2500	180	40

** Nm 40 on request

Three phase 4/6 poles 1500/1000 r.p.m.

Type	kW	r.p.m.	Cos φ	I n V.400	Ma/Mn	I.A/I.N	Inertia Jx Kgm ²	Braking torque MAX Nm.	AVV. C/h	In - V.400AC brake D.C. (m A)	Kg.
FKDA71A4/6	0,13	1360	0,70	0,7	2,3	4,5	0,00091	8	7000	90	8
	0,08	890	0,64	0,4	2,0	3			10000		
FKDA71B4/6	0,18	1370	0,72	0,7	2,3	4,5	0,00123	8	7000	90	8,5
	0,11	900	0,67	0,5	2,2	2,9			10000		
FKDA80A4/6	0,26	1390	0,75	1,0	2,4	4,8	0,00223	8	7000	90	12
	0,18	930	0,68	0,9	2,0	3			10000		
FKDA80B4/6	0,37	1400	0,76	1,1	2,5	4,8	0,00280	8	6000	90	13
	0,26	930	0,69	1,0	2,0	3			8000		
FKDA90SA4/6	0,55	1410	0,77	1,8	2,4	5,5	0,00356	20	6000	180	17
	0,37	945	0,70	1,6	2,1	3,6			8000		
FKDA90LA4/6	0,75	1410	0,79	2,4	2,3	5,6	0,00472	20	9500	180	20
	0,55	945	0,60	2	2,2	3,3			8000		
FKDA100LB4/6	1,50	1420	0,79	3,9	2,6	5,6	0,00996	20**	4000	180	28
	1,10	945	0,70	3,2	2,3	3,5			6000		
FKDA112MB4/6	2,00	1430	0,86	4,5	2,4	5,3	0,01680	20**	2000	180	43
	1,30	950	0,71	3,6	2,0	4,5			3000		

** Nm 40 on request

Trifase 4-8 poles - 1500/750 r.p.m.

Type	kW	r.p.m.	Cos φ	I n V.400	Ma/Mn	I.A/I.N	Inertia moment Jx Kgm ²	Braking torque MAX Nm.	AVV. C/h	In - V.400AC brake D.C. (m A)	Kg.
FKD71A4/8	0,13	1360	0,83	0,5	2,0	3,7	0,00091	8	12000	90	10
	0,07	680	0,62	0,5	2,2	2,5			20000		
FKD71B4/8	0,18	1360	0,82	0,7	2,2	3,8	0,00123	8	10000	90	10,5
	0,09	680	0,63	0,7	1,9	2,6			20000		
FKD71C4/8	0,22	1360	0,80	0,8	2,1	3,9	0,00141	8	9000	90	11
	0,12	670	0,60	0,8	1,9	2,7			20000		
FKD80A4/8	0,26	1410	0,83	0,9	2,2	5,5	0,00203	8	7000	90	14,5
	0,18	6750	0,60	0,9	1,9	3,0			14000		
FKD80B4/8	0,37	1405	0,84	0,9	2,3	5,5	0,00280	8	7000	90	15,5
	0,26	675	0,64	1,2	2,0	2,8			14000		
FKD90SA4/8	0,75	1400	0,85	2,1	1,9	4,0	0,00356	20	6500	180	20
	0,37	700	0,60	1,9	2,2	3,0			12000		
FKD90LB4/8	1,10	1400	0,85	2,7	2,0	4,0	0,00505	20	6000	180	24
	0,60	700	0,58	3,0	2,2	3,0			10000		
FKD100LB4/8	1,60	1440	0,85	3,7	2,2	4,6	0,00996	20**	4000	180	39,7
	0,90	700	0,61	3,5	2,2	3,2			8000		
FKD112MB4/8	2,20	1440	0,89	4,6	2,2	5,6	0,01680	20**	2000	180	42
	1,20	710	0,59	4,8	3,0	4,0			4000		

** Nm 40 on request

Overall dimensions

B3

Type	A	B	C	D	E	F	G	H	K	I	O	L	M	Q	T	U	V	Z	W	Y	X
FK 56	90	71	36	9	20	3	7,2	56	6	7	100	75	75	230	132	3	114	95	96	111	M4
FK 63	100	80	32	11	23	4	8,5	63	7	7	110	81	75	255	156	4	120	97	93	125	M4
FK 71	112	90	45	14	30	5	11	71	7	7	112	81	75	280/295*	173	5	134	108	102	140	M5
FK 80	125	100	50	19	40	6	15,5	80	7	8	118	98,5	75	340	194	6	156	126	114	157	M6
FK 90 S	140	100	56	24	50	8	20	90	9	10	150	98,5	98,5	380	218	7	176	128	128	179	M8
FK 90 L	140	125	56	24	50	8	20	90	9	10	150	98,5	98,5	410	218	7	176	151	128	179	M8
FK 100	160	140	60	28	60	8	24	100	9	10	155	98,5	98,5	430	241	7	196	166	141	194	M8
FK 112	190	140	72	28	60	8	24	112	12	15	160	98,5	98,5	470	264	7	230	166	152	222	M8

B5

Type	N	B	C	D	E	F	G	P	O	A	L	M	X	Q	S	U	W	Y
FK 56	80	75	M4	9	20	3	7,2	120	100	2,5	75	100	9	230	7,5	3	96	111
FK 63	95	75	M4	11	23	4	8,5	140	110	2,5	81	115	9	255	9,5	4	93	125
FK 71	110	75	M5	14	30	5	11	160	112	3,5	81	130	10	280/295*	9,5	5	102	140
FK 80	130	75	M6	19	40	6	15,5	200	117	3,5	81	165	12	340	11,5	6	114	157
FK 90 S	130	98,5	M8	24	50	8	20	200	150	3,5	98,5	165	12	380	11,5	7	128	179
FK 90 L	130	98,5	M8	24	50	8	20	200	150	3,5	98,5	165	12	410	11,5	7	128	179
FK 100	180	98,5	M8	28	60	8	24	250	155	3,5	98,5	215	14	430	14	7	141	194
FK 112	180	98,5	M8	28	60	8	24	250	160	3,5	98,5	215	14	470	14	7	151	222

B14

Type	N	O	C	D	E	F	G	B	K	L	M	P	Q	S	U	W	Y	A	Z	R	X
FK 56	50	100	M4	9	20	3	7,2	75	2,5	75	65	80	230	M5	3	96	111	—	—	—	—
FK 63	60	110	M4	11	23	4	8,5	75	2,5	81	75	90	255	M5	4	93	125	—	—	—	—
FK 71	70	112	M5	14	30	5	11	75	2,5	81	85	105	280/295*	M6	5	102	140	135,5	128	83	107
FK 80	80	117	M6	19	40	6	15,5	75	3	81	100	120	340	M6	6	114	157	140,5	128	83	116
FK 90 S	95	150	M8	24	50	8	20	98,5	3	98,5	115	140	380	M8	7	128	179	170	160	107	131
FK 90 L	95	150	M8	24	50	8	20	98,5	3	98,5	115	140	410	M8	7	128	179	170	160	107	131
FK 100	110	155	M8	28	60	8	24	98,5	3,5	98,5	130	160	430	M8	7	141	194	179	160	107	141
FK 112	110	160	M8	28	60	8	24	98,5	3,5	98,5	130	160	470	M8	7	151	222	180	160	107	141

*FKL

SW-SERIES

Asynchronous brake motors

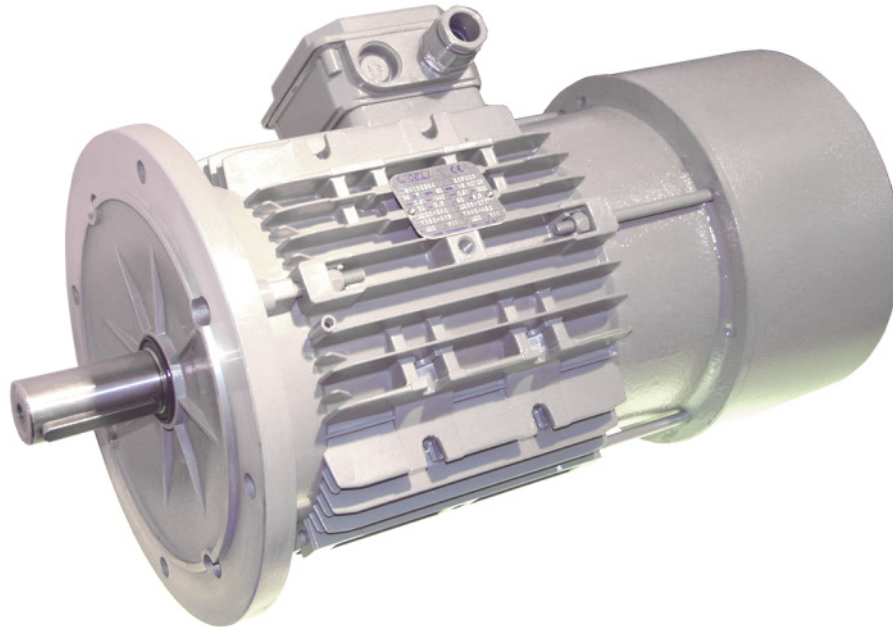

SW series brake motors are not ventilated, suitable for S2 or S3 duty (depending on polarity), totally enclosed. This series has been designed for those kind of applications where the brake motor has often contacts with water such as marine applications or where you need to wash the motor to keep it clean. These motors are painted as standard with special painting for a total protection. The protection level of this series is IP56 as standard. All the motor cases are made in aluminium and are available in cast iron on request.

Features

- Disk brake without axial sliding of the shaft.
- Adjustment of braking torque within very ample values.
- Brake operation within very low noise and amperage levels.
- SW motors are fitted with DC electromagnet as standard. The electromagnet three-phase can be fitted on request.
- On SW series the manual brake release is not suitable as standard feature due to ensure a real and complete protection of the brake part.
- Brakes mounted on SW series as standard are FK type for frame 90/100 and F type for 112/160; for further information about brake maintenance and characteristics, please see related pages to F (page15) or FK (page31) of this catalogue.

Possible product configurations

- | | |
|--|--|
| <ul style="list-style-type: none"> - Motors with feet (B3) - Motors with feet and flange - Motors with flange B5 or B14 - Motors with B5 reduced flange from frame 90 to 160 - Motors with B14 reduced flange from frame 90 to 100 - Reduced shafts - Special shafts - Motors B3 with terminal box on the side (up side on series) - Special windings | <ul style="list-style-type: none"> - Separated brake supply - AC brake - Insulance in H class - Special "P" rotor for start up torque increasing - Special painting (also for marine ambient) - Thermal protections - Anti condense resistors - R or S level equilibration of the rotor - Custom executions |
|--|--|

For other special requests, please contact COEL

Overall Dimensions

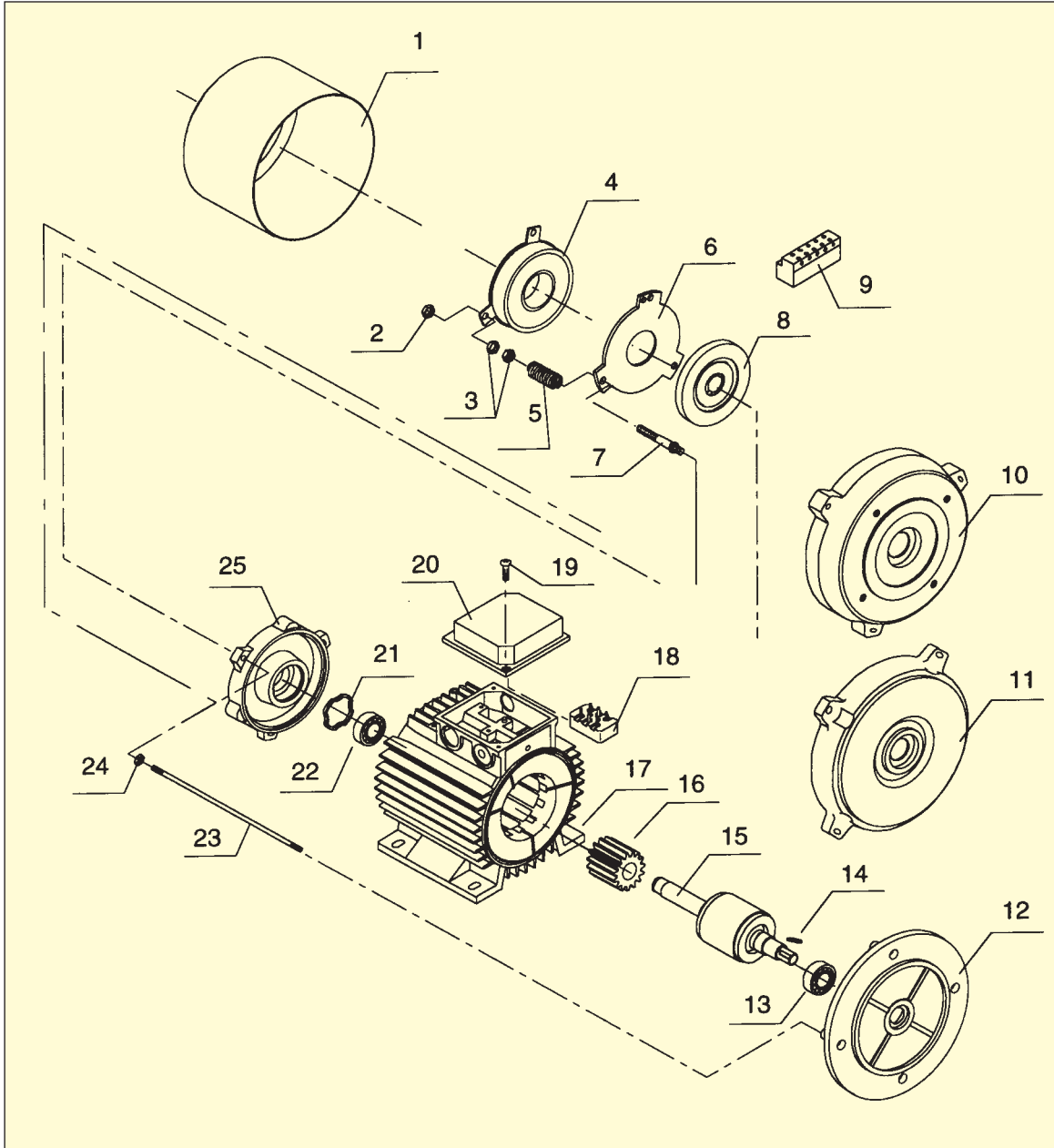

- | | |
|------------------------------|---|
| 1 Brake cover | 15 Rotor - shaft group |
| 2 Electromagnet locking nuts | 16 Brake gear |
| 3 Adjustment nuts | 17 Motor case and winded stator |
| 4 Electromagnet | 18 Terminal board |
| 5 Brake spring | 19 Terminal board base cover nuts |
| 6 Mobil anchor | 20 Terminal board base cover |
| 7 Guide drawrods | 21 Compensation ring |
| 8 Brake disk | 22 Back side bearing |
| 9 Rectifier | 23 Drawroads kit |
| 10 B14 flange | 24 Drawroad nuts |
| 11 Front shield | 25 Back side shield with frictional track |
| 12 B5 flange | |
| 13 Front bearing | |
| 14 Key | |

Three phase 2 poles - 3000 r.p.m.

Type	Kw S2 25min.	r.p.m.	Cos. ϕ	I n V.400	Ma/Mn	I.A/I.N	Inertia moment Jx Kg m^2	Braking Torque MAX Nm.	Starts C/h	A.V.400 Brake A.C. (m A)	A. V.230AC brake D.C. (m A)	KG.
SW90SA2	1,50	2780	0,86	3,50	2,5	6,8	0,00189	20	4000	180	300	17
SW90SB2	1,84	2780	0,86	4,30	2,5	6,8	0,00200	20	3500	180	300	18
SW90LA2	2,20	2800	0,88	4,70	2,5	6,8	0,00232	20	3000	180	300	20
SW100LA2	3,00	2800	0,88	6,50	2,9	8,0	0,00572	40	1200	250	350	25
SW112MB2	4,00	2820	0,87	8,20	2,4	7,4	0,00720	80	900	500	550	45
SW132SA2	5,50	2880	0,85	11,0	2,3	7,5	0,03100	150	500	800	600	78,5
SW132SB2	7,50	2880	0,85	15,0	2,3	7,5	0,03320	150	500	800	600	84,5
SW132MA2*	9,20	2870	0,88	18,0	2,3	7,5	0,03980	150	500	800	600	87
SW160MA2	11,00	2890	0,88	20,8	3,0	9,0	0,06020	175	300	800	600	148
SW160MB2	15,00	2900	0,87	29,0	3,0	8,0	0,06260	175	300	800	600	150
SW160LA2	18,50	2900	0,90	33,0	3,0	8,0	0,08960	175	290	800	600	167

Three phase 4 poles - 1500 r.p.m.

Type	Kw S2 25min.	r.p.m.	Cos. ϕ	I n V.400	Ma/Mn	I.A/I.N	Inertia moment Jx Kg m^2	Braking Torque MAX Nm.	Starts C/h	A.V.400 Brake A.C. (m A)	A. V.230AC brake D.C. (m A)	KG.
SW90SA4	1,10	1400	0,77	2,7	2,30	4,6	0,00284	20	10000	180	300	20
SW90LA4	1,50	1400	0,75	3,7	3,00	4,9	0,00305	20	10000	180	300	22
SW90LB4*	1,85	1400	0,77	4,3	3,00	4,6	0,00388	20	9000	180	300	24
SW90LC4*	2,20	1400	0,78	5,4	2,90	4,3	0,00430	20	8000	250	300	26
SW100LA4	2,20	1410	0,78	5,0	2,70	5,5	0,00572	40	7500	250	350	36.3
SW100LB4	3,00	1410	0,82	6,4	2,70	5,0	0,00612	40	7000	250	350	39.7
SW100LC4*	3,30	1410	0,80	7,5	2,60	4,7	0,00750	40	7000	250	350	41
SW112MB4	4,00	1430	0,85	8,2	2,70	5,8	0,01180	80	3300	500	550	47
SW132SB4	5,50	1440	0,81	11,3	2,60	5,8	0,03320	150	1200	800	600	84,5
SW132MA4	7,50	1430	0,85	14,6	2,30	5,8	0,03900	150	1000	800	600	94,5
SW132MB4*	9,00	1430	0,84	17,9	2,30	5,8	0,04620	150	900	800	600	100
SW160MB4	11,00	1460	0,80	22,0	2,80	5,9	0,06260	175	600	800	600	148
SW160LA4	15,00	1460	0,82	29,0	2,30	5,9	0,08960	175	600	800	600	167
SW160LB4*	18,50	1450	0,83	37,0	2,20	5,8	0,09480	175	600	800	600	190

* Non unified powers

Three phase 6 poles - 1000 r.p.m.

Type	Kw S2 20min.	r.p.m.	Cos. φ	I n V.400	Ma/Mn	I.A/I.N	Inertia moment Jx Kgm ²	Braking Torque MAX Nm.	Starts C/h	A.V.400 Brake A.C. (m A)	A. V.230AC brake D.C. (m A)	KG.
SW90SA6	0,75	910	0,68	2,3	2,2	3,3	0,00356	20	18000	250	300	16
SW90LA6	1,10	910	0,68	3,3	2,3	3,7	0,00472	20	14000	250	300	19
SW100LA6	1,50	930	0,71	3,9	2,4	4,3	0,00874	40	9000	250	350	27
SW100LB6*	1,85	920	0,68	5,0	2,6	4,3	0,00996	40	8500	250	350	30
SW112MB6	2,20	940	0,78	5,2	2,3	5,3	0,01680	80	4500	500	550	47
SW132SB6	3,00	960	0,76	7,0	2,1	5,6	0,03100	150	3000	800	600	84,5
SW132MA6	4,00	960	0,76	9,1	2,7	5,6	0,04250	150	3000	800	600	94,5
SW132MB6	5,50	960	0,78	12	2,1	5,5	0,05150	150	2800	800	600	100
SW160MB6	7,50	950	0,79	18	2,1	5,6	0,09700	175	900	800	600	148
SW160LA6*	9,50	950	0,80	22	2,0	5,5	0,1230	175	900	800	600	170
SW160LB6	11,00	960	0,80	26	2,0	5,5	0,1433	175	900	800	600	175

Three phase 8 poles - 750 r.p.m.

Type	Kw S2 20min.	r.p.m.	Cos. φ	I n V.400	Ma/Mn	I.A/I.N	Inertia moment Jx Kgm ²	Braking Torque MAX Nm.	Starts C/h	A.V.400 Brake A.C. (m A)	A. V.230AC brake D.C. (m A)	KG.
SW90SA8	0,37	690	0,56	1,6	2,2	2,8	0,00356	20	20000	250	300	16
SW90LA8	0,55	690	0,57	2,3	2,2	2,9	0,00472	20	18000	250	300	19
SW100LA8	0,75	700	0,59	2,8	2,3	3,2	0,00874	40	12000	250	350	27
SW100LB8	1,10	700	0,60	3,6	2,1	3,5	0,00996	40	10000	250	350	30
SW112MB8	1,50	710	0,65	4,5	1,9	4,0	0,01680	80	5000	500	550	46
SW132SB8	2,20	715	0,72	5,3	1,7	4,8	0,03100	150	3200	800	600	85
SW132MA8	3,00	720	0,69	8,5	1,8	4,8	0,04250	150	3000	800	600	93,5
SW160MA8	4,00	710	0,71	11	2,0	5,0	0,09500	175	1200	800	600	135
SW160MB8	5,50	710	0,73	13	2,0	5,0	0,12300	175	1100	800	600	150
SW160LA8	7,50	710	0,71	18	2,2	5,0	0,11800	175	1000	800	600	175

* Non unified powers

Three phase 2/4 poles - 3000/1500 r.p.m.

Type	kW S2 20min.	r.p.m.	Cos. φ	I n V.400	M.A/ M.N	I.A/ I.N	Inertia moment Jx Kg ^m ²	Braking Torque MAX Nm.	Starts C/h	A.V.400 Brake A.C. (m A)	A. V.400AC brake D.C. (m A)	KG.
SWD90SB2/4	1,3 0,9	2800 1420	0,85 0,73	3,3 2,4	2,3 2,3	4,7 4,5	0,00305	20	2000 7500	250	180	20
SWD90LA2/4	1,8 1,2	2800 1420	0,81 0,71	4,5 3,2	2,7 2,9	4,9 4,8	0,00388	20	2000 7000	250	180	22
SWD90LB2/4	2,2 1,5	2800 1400	0,80 0,74	5,5 3,9	2,7 3,0	4,9 4,6	0,00572	20	1800 7000	250	180	24
SWD100LA2/4	2,5 1,9	2860 1420	0,85 0,82	5,2 3,9	2,6 2,4	6,2 5,4	0,00612	40	1000 5500	250	200	36.3
SWD100LB2/4	3,3 2,4	2870 1420	0,85 0,77	7,0 5,3	2,8 2,5	7,0 6,3	0,01180	40	1000 5000	250	200	39.7
SWD112MB2/4	4,5 3,3	2880 1410	0,87 0,86	9,3 6,9	2,4 2,3	7,0 6,3	0,03120	80	500 2000	500	550	48
SWD132SB2/4	5,1 4,5	2810 1400	0,91 0,81	11 10	2,7 2,5	5,1 5,8	0,04000	150	450 1500	800	600	84.5
SWD132MA2/4	6,0 5,0	2810 1400	0,93 0,80	12,5 12,0	3,0 2,8	5,2 5,8	0,05900	150	400 1000	800	600	94.5
SWD160MA2/4	9,50 8,0	2800 1410	0,86 0,85	17 15	2,8 2,3	8,5 5,8	0,06260	175	200 400	800	600	142
SWD160MB2/4	11 9,0	2830 1410	0,86 0,86	24 20	2,4 2,3	8,5 5,6	0,08960	175	200 350	800	600	150
SWD160LA2/4	13 11	2830 1450	0,86 0,84	27 22	2,5 2,2	8,8 5,5	0,16700	175	150 300	800	600	170

Three phase 2/6 poles - 3000/1000 r.p.m.

Type	kW S3 40%.	r.p.m.	Cos. φ	I n V.400	M.A/ M.N	I.A/ I.N	Inertia moment Jx Kg ^m ²	Braking Torque MAX Nm.	Starts C/h	A.V.400 Brake A.C. (m A)	A. V.400AC brake D.C. (m A)	Weight KG.
SWDA90SA2/6	0,90 0,30	2870 940	0,84 0,64	2,1 1,2	2,6 2,2	6,5 2,5	0,00284	20	1900 9000	250	180	20
SWDA90LA2/6	1,20 0,40	2870 950	0,81 0,66	2,9 1,7	2,3 2,0	6,3 3,5	0,00305	20	1800 8000	250	180	22
SWDA100LB2/6	2,20 0,80	2800 910	0,85 0,64	4,9 2,6	2,7 2,2	6,7 3,5	0,00612	40	900 6000	250	200	39
SWDA112MB2/6	3,00 1,00	2880 930	0,85 0,62	6,60 3,50	2,9 2,3	7,1 4,0	0,01180	80	500 4000	500	550	48
SWDA132SB2/6	4,00 1,50	2860 920	0,84 0,58	9,5 4,3	2,6 2,1	8,6 5,1	0,03120	150	350 1600	800	600	85
SWDA132MB2/6	6,45 2,20	2860 910	0,82 0,60	15,0 7,5	2,7 2,1	8,3 5,5	0,04620	150	350 1600	800	600	102
SWDA160LA2/6	11,00 3,40	2860 960	0,84 0,58	20,0 12,0	2,7 2,2	7,1 4,2	0,08960	175	250 900	800	600	170

Three phase 2/8 poles - 3000/750 r.p.m.

Type	kW S3 40%	r.p.m.	Cos. φ	I n V.400	M.A/ M.N	I.A/ I.N	Inertia moment Jx Kgm ²	Braking Torque MAX Nm.	Starts C/h	A.V.400 Brake A.C. (m A)	A. V.400AC brake D.C. (m A)	KG.
SWDA90SB2/8	0,75 0,18	2820 700	0,70 0,54	2,1 1,1	2,6 1,9	5,5 2,3	0,00295	20	1900 10000	250	180	17
SWDA90LA2/8	1,10 0,30	2820 700	0,75 0,55	2,7 1,5	2,5 1,9	5,6 2,4	0,00305	20	1800 10000	250	180	20
SWDA90LB2/8	1,30 0,30	2820 700	0,78 0,58	3,1 1,8	2,4 2	5,8 2,3	0,00388	20	1800 9000	250	180	21
SWDA100LA2/8	1,50 0,37	2820 700	0,78 0,56	3,9 2,2	2,6 1,8	5,6 2,8	0,00572	40	1000 7000	250	200	20
SWDA100LB2/8	2,20 0,50	2840 700	0,87 0,58	4,9 2,8	2,5 1,8	5,1 2,9	0,00612	40	900 3000	250	200	30
SWDA112MA2/8	2,50 0,60	2840 705	0,74 0,57	5,8 3,2	2,4 1,9	5,5 3,0	0,00950	80	500 2500	500	550	47
SWDA112MB2/8	3,00 0,80	2850 705	0,74 0,59	6,7 3,6	2,5 2	6,0 3,0	0,01180	80	500 2500	500	550	48
SWDA132SB2/8	4,00 1,10	2860 700	0,74 0,60	10,0 4,0	2,6 1,9	6,5 2,9	0,03120	150	300 1500	800	600	84,5
SWDA132MA2/8	5,50 1,50	2870 700	0,75 0,61	12,0 5,6	2,5 2,1	6,6 3,0	0,04000	150	300 1300	800	600	94,5
SWDA132MB2/8	6,20 1,80	2860 690	0,82 0,67	13,7 6,8	2,5 2,1	6,6 3,0	0,04620	150	300 1300	800	600	100
SWDA160LA2/8	11,00 3,00	2900 720	0,90 0,63	24,0 14,0	2,4 2,2	6,8 3,4	0,08960	175	300 1300	800	600	170

Three phase 4/6 poles 1500/1000 r.p.m.

Type	kW S3 40%.	r.p.m.	Cos. φ	I n V.400	M.A/ M.N	I.A/ I.N	Inertia moment Jx Kgm ²	Braking Torque MAX Nm.	Starts C/h	A.V.400 Brake A.C. (m A)	A. V.400AC brake D.C. (m A)	KG.
SWDA90SA4/6	0,55 0,37	1410 945	0,77 0,70	1,8 1,6	2,4 2,1	5,5 3,6	0,00356	20	6000 8000	250	180	17
SWDA90LA4/6	0,75 0,55	1410 945	0,79 0,60	2,4 2	2,3 2,2	5,6 3,3	0,00472	20	9500 8000	250	180	20
SWDA100LB4/6	1,50 1,10	1420 945	0,79 0,70	3,9 3,2	2,6 2,3	5,6 3,5	0,00996	40	4000 6000	250	200	28
SWDA112MB4/6	2,00 1,30	1430 950	0,86 0,71	4,5 3,6	2,4 2,0	5,3 4,5	0,01680	80	2000 3000	500	550	48
SWDA132SB4/6	2,20 1,50	1430 930	0,84 0,71	5,0 3,7	2,3 1,9	6 3,4	0,03100	150	600 1000	800	600	84,5
SWDA132MA4/6	3,00 2,20	1430 930	0,84 0,72	6,0 5,2	2,4 2,2	6,0 3,6	0,04250	150	800 1200	800	600	94,5
SWDA132MB4/6	3,70 2,60	1440 930	0,84 0,72	8,3 6,2	2,3 2,2	6,1 3,8	0,04950	150	700 1000	800	600	100
SWDA160MB4/6	5,50 3,70	1450 930	0,85 0,75	12 8,5	2,2 2,0	7 4	0,10700	175	500 700	800	600	148
SWDA160LB4/6	7,50 5,50	1450 930	0,84 0,76	17,5 13,5	2,3 2,0	7 4	0,14350	175	400 700	800	600	180

Three phase 4/8 poles - 1500/750 r.p.m.

Type	kW S3 40%.	r.p.m.	Cos. φ	I n V.400	M.A/ M.N	I.A/ I.N	Inertia moment Jx Kgm ²	Braking Torque MAX Nm.	Starts C/h	A.V.400 Brake A.C. (m A)	A. V.400AC brake D.C. (m A)	KG.
SWD90SA4/8	0,75 0,37	1400 700	0,85 0,60	2,1 1,9	1,9 2,2	4,0 3,0	0,00356	40	6500 12000	250	180	20
SWD90LB4/8	1,10 0,60	1400 700	0,85 0,58	2,7 3,0	2,0 2,2	4,0 3,0	0,00510	40	6000 10000	250	180	24
SWD100LB4/8	1,60 0,90	1440 700	0,85 0,61	3,7 3,5	2,2 2,2	4,6 3,2	0,00996	48	4000 8000	250	200	39,7
SWD112MB4/8	2,20 1,20	1440 710	0,89 0,59	4,6 4,8	2,2 3,0	5,6 4,0	0,01680	80	2000 4000	500	550	48
SWD132SB4/8	3,00 2,00	1430 715	0,88 0,59	6,1 6,9	2,7 2,5	5,5 3,5	0,03100	150	700 2000	800	600	84,5
SWD132MA4/8	4,00 2,60	1445 720	0,87 0,63	8,0 8,5	3,0 2,9	5,6 5,5	0,04250	150	500 1500	800	600	98
SWD160MA4/8	5,50 3,70	1430 720	0,86 0,64	11,5 12,5	2,5 2,1	5,8 5,3	0,09500	175	600 1200	800	600	139
SWD160MB4/8	6,60 4,50	1430 720	0,88 0,65	14,5 13,8	2,3 2,2	5,9 5,3	0,09700	175	600 1200	800	600	148
SWD160LA4/8	9,60 6,00	1430 720	0,86 0,66	21 19	2,6 2,1	6,0 5,1	0,12300	175	550 1100	800	600	170

*Three phase 4-12 poles - 1500/500 r.p.m.
hoisting application*

Type	kW S3 30%-15%	I n V.400	Type	kW S3 30%-15%	I n V.400
SWDA71C4/12	0,20 0,08	1,20 0,80	SWDA112MC4/12	4,50 1,50	11,0 7,00
SWDA80C4/12	0,55 0,18	1,70 1,20	SWDA132MB4/12	6,10 1,75	13,6 9,70
SWDA90LB4/12	0,80 0,30	2,50 2,20	SWDA132MC4/12	7,70 2,50	17,0 11,5
SWDA100LB4/12	1,70 0,60	3,40 2,90	SWDA160LB4/12	14,0 4,80	30,0 24,0
SWDA112MB4/12	3,20 1,10	8,00 6,00	SWDA160LC4/12	16,5 5,15	33,0 29,0

*Three phase 4-16 poles - 1500/375 r.p.m.
hoisting application*

Type	kW S3 30%-15%	I n V.400
SWDA112MB4/16	1,6 0,4	4,6 3,8
SWDA132SA4/16	2,80 0,70	6,5 4,8
SWDA132MA4/16	4,00 1,00	8,8 7,2
SWDA132MB4/16	5,5 1,3	13,8 12,0
SWDA160MB4/16	6,80 1,70	18,0 15,0
SWDA160LA4/16	9,00 2,20	23,0 21,0
SWDA160LB4/16	10,5 2,60	24,0 22,0
SWDA180LB4/16	13,0 3,20	32,5 17,8
SWDA200LB4/16	16,0 4,00	41,0 22,0

Overall Dimensions

B3

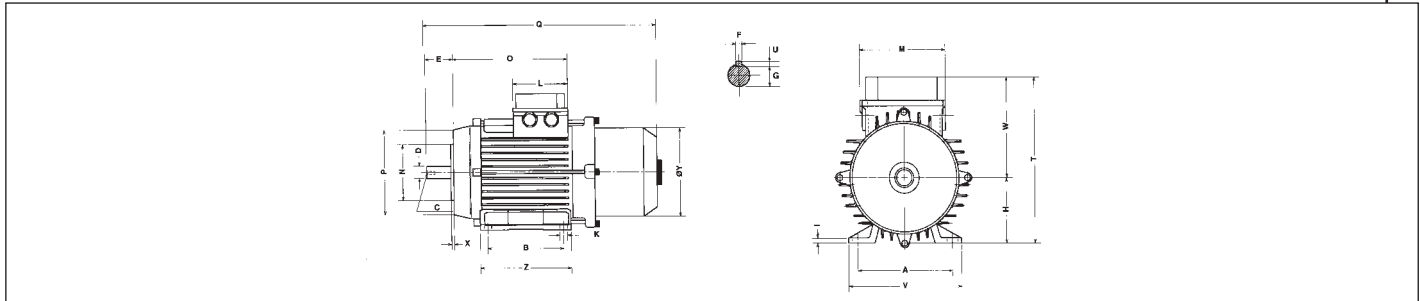

Type	A	B	C	D	E	F	G	H	K	L	M	Q	T	O	W	Y	U	X	V	Z
SW90 S	140	100	56	24	50	8	20	90	9	98	99	330	218	174	128	179	7	M8	176	128
SW90 L	140	125	56	24	50	8	20	90	9	98	99	355	218	196	128	179	7	M8	176	151
SW100	160	140	63	28	60	8	24	100	9	98	99	400	241	218	141	179	7	M8	196	166
SW112	190	140	70	28	60	8	24	112	12	98	99	520	263	226	151	220	7	M8	230	166
SW132S	216	140	89	38	80	10	33,5	132	12	120	110	612	329	257	197	255	8	M10	262	166
SW132M	216	178	89	38	80	10	33,5	132	12	120	110	650	329	297	197	255	8	M10	262	205
SW160M	254	210	108	42	110	12	37,5	160	14	180	140	700	386	331	226	314	8	M12	306	240
SW160L	254	254	108	42	110	12	37,5	160	14	180	140	740	386	371	226	314	8	M12	306	284

B5

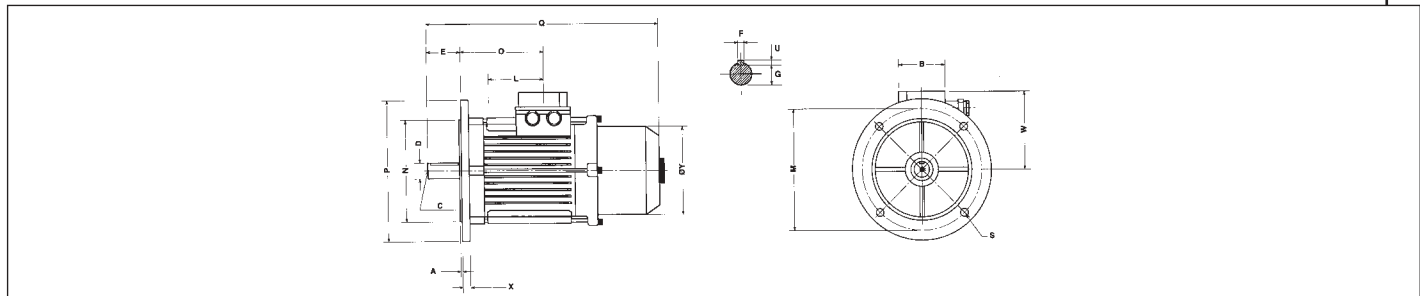

Type	N	B	C	D	E	F	G	H	P	I	L	M	O	Q	S	U	A	X	W	Y
SW90 S	130	99	M8	24	50	8	20	-	200	-	98	165	182	330	11,5	7	3,5	12	128	179
SW90 L	130	99	M8	24	50	8	20	-	200	-	98	165	207	355	11,5	7	3,5	12	128	179
SW100	180	99	M8	28	60	8	24	-	250	-	98	215	218	400	14	7	3,5	14	141	179
SW112	180	99	M8	28	60	8	24	-	250	-	98	215	229	520	14	7	3,5	14	151	222
SW132S	230	110	M10	38	80	10	33,5	-	300	-	120	265	260	612	14	8	3,5	14	197	255
SW132M	230	110	M10	38	80	10	33,5	-	300	-	120	265	300	650	14	8	3,5	14	197	255
SW160M	250	140	M12	42	110	12	37,5	-	350	-	140	300	330	700	18	8	4	16	250	314
SW160L	250	140	M12	42	110	12	37,5	-	350	-	140	300	330	740	18	8	4	16	250	314

B14

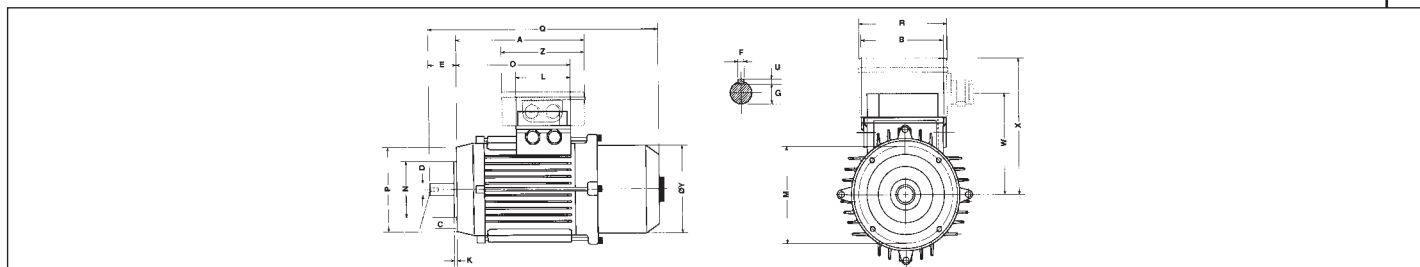

Type	N	B	C	D	E	F	G	H	P	I	L	M	O	Q	S	U	X	Z	W	Y	T	R	V	K
SW90S	95	99	M8	24	50	8	20	-	140	-	98	115	171	330	M8	7	3,5	-	128	179	202	160	107	131
SW90L	95	99	M8	24	50	8	20	-	140	-	98	115	196	355	M8	7	3,5	-	128	179	227	160	107	131
SW100	110	99	M8	28	60	8	24	-	160	-	98	130	218	400	M8	7	3,5	-	141	180	249	160	107	141
SW112	110	99	M8	28	60	8	24	-	160	-	98	130	226	520	M8	7	3,5	-	151	222	257	160	107	151
SW132S	130	110	M10	38	80	10	33,5	-	200	-	120	165	260	612	M10	8	3,5	-	197	263	---	---	---	---
SW132M	130	110	M10	38	80	10	33,5	-	200	-	120	165	300	650	M10	8	3,5	-	197	263	---	---	---	---

FM-SERIES

Asynchronous brake motors

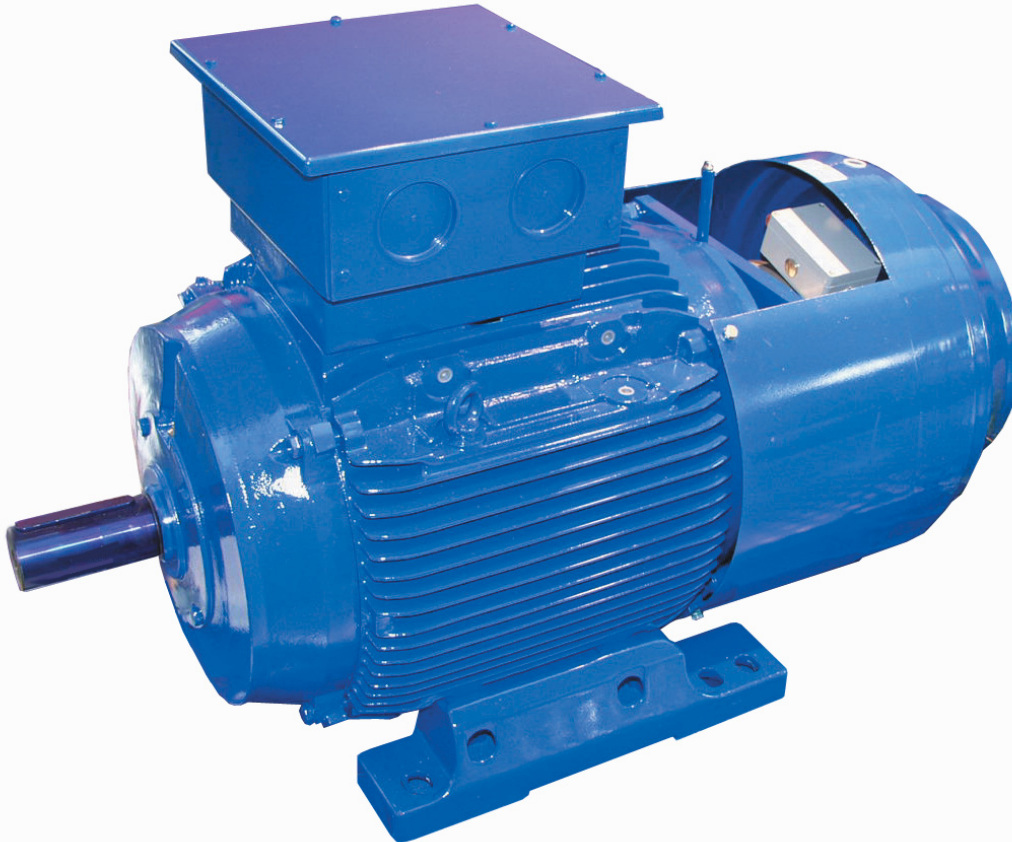

FM series brake motors are externally ventilated and completely closed.

FM motors are available from frame 225 to 315; all the components of the motor parts are in cast iron and the motors are supplied painted blue RAL5010.

The brakes mounted are DC and made to ensure a very long life. The type of brake mounted can be changed on request (for further information see tech. tabs).

The very strong structure of FM series brake motors ensures high reliability for high power applications.

The brake current supply is separated from the motor supply as standard.

Characteristics

- Brake disk without axial movement of the shaft
- Operation of the brake within very low values of noise and amperage
- Compact dimensions
- DC brake as standard

Possible product configurations

- | | |
|---------------------------------------|--|
| - Motors with feet (B3) | - H class insulation |
| - Motors with feet and flange | - IP protection higher than standard |
| - Motors with flange B5 | - Special painting |
| - Double shafts | - Thermal protections |
| - Special shafts | - Anti condense resistors |
| - Motors B3 with lateral terminal box | - R or S type equilibration of the rotor |
| - Custom motors | - Motors with encoder |
| - Special windings | - Lateral brake hand release |
| - Auxiliary fan | - Version with encoder |

For further information please contact Coel

Spare parts

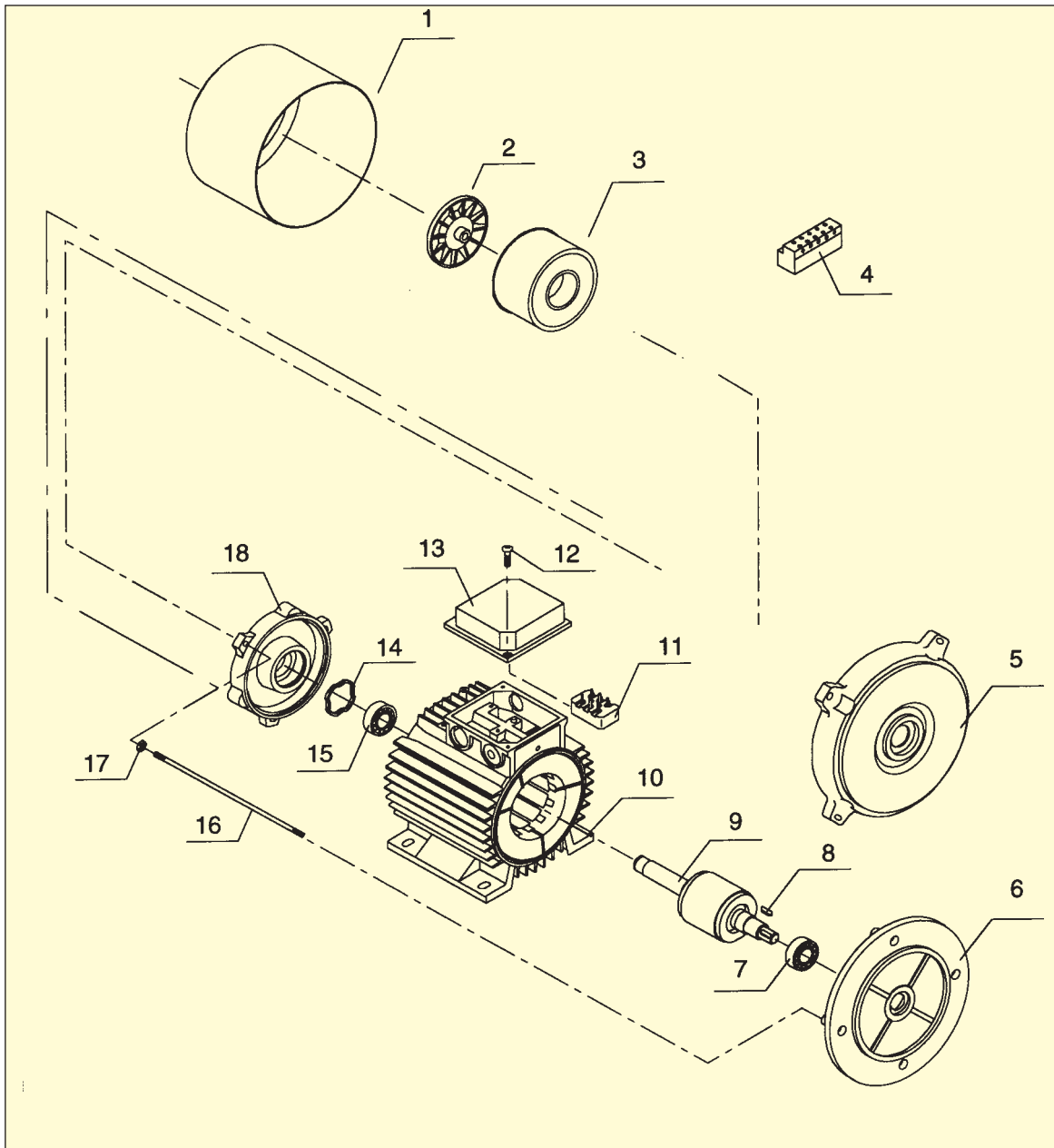

1 Fan cover	10 Motor case with winded stator
2 Fan	11 Terminal board
3 Brake group	12 Terminal board cover nuts
4 Rectifier	13 Terminal board cover
5 B3 shield	14 Compensation ring
6 B5 flange	15 Back side bearing
7 Front bearing	16 Drawrods
8 Key	17 Drawrod nuts
9 Rotor shaft group	18 Back side shield

Three phase 2 - 4 - 6 - 8 poles

Type	kW	r.p.m.	In V.400	Cos. φ	n%	Ma/Mn	Ia/In	J	Kg	Braking Torque Nm.	W brake
FM225M2	45	2950	81	0,88	91,5	3,3	7,5	0,21	285	700	180
FM250M2	55	2950	95	0,9	92,5	3,3	7	0,34	360	700	180
FM280S2	75	2950	129	0,9	93,5	2,2	6,8	0,62	530	700	180
FM280M2	90	2960	155	0,89	94	2,4	7,5	0,72	570	700	180
FM315S2	110	2950	186	0,91	94	2,5	7	1,2	760	1600	325
FM315M2	132	2960	224	0,9	94,5	2,5	7,5	1,35	810	1600	325
FM315MA2	160	2975	280	0,88	94,5	3	8	2,1	1000	1600	325
FM315MB2	200	2980	335	0,9	95,5	3	8,5	2,55	1120	1600	325
FM225S4	37	1465	70	0,84	91	3,8	7	0,35	280	700	180
FM225M4	45	1465	83	0,85	92	3,8	7	0,42	315	700	180
FM250M4	55	1470	102	0,85	92	3,3	7	0,64	370	700	180
FM280S4	75	1475	135	0,86	93,5	2,4	7	1,2	550	700	180
FM280M4	90	1475	162	0,86	93,5	2,4	7	1,35	590	700	180
FM315S4	110	1480	196	0,86	94	2,8	8	2,35	790	1600	325
FM315M4	132	1480	230	0,88	94	2,8	8	2,7	860	1600	325
FM315MA4	160	1480	275	0,89	94,5	2,3	6,8	3,6	980	1600	325
FM315MB4	200	1480	345	0,88	94,5	2,6	7,5	4,4	1100	1600	325
FM225S6	26	970	50	0,84	89	3,3	6,3	0,47	260	700	180
FM225M6	30	970	56	0,86	90	3,5	7	0,54	280	700	180
FM250M6	37	975	67	0,87	91	3,5	7	1	360	700	180
FM280S6	45	980	82	0,87	91,5	2,8	6,5	1,8	540	700	180
FM280M6	55	980	98	0,88	92	3	7	2,05	580	700	180
FM315S6	75	985	132	0,88	93	3,5	8,5	3,6	780	1600	325
FM315M6	90	985	157	0,88	94	3,3	7,5	4,1	850	1600	325
FM315MA6	110	985	199	0,86	93	3,5	8	5,5	970	1600	325
FM315MB6	132	985	230	0,88	94	3,5	8,5	6,7	1090	1600	325
FM225S8	18,5	730	39,5	0,76	89	3,3	5,5	0,47	260	700	180
FM225M8	22	730	47	0,76	89	3	5,3	0,54	280	700	180
FM250M8	30	730	62	0,78	90	3,5	6	1	360	700	180
FM280S8	37	730	74	0,79	91	2,6	5,8	1,8	540	700	180
FM280M8	45	730	90	0,79	91,5	2,8	6	2,05	580	700	180
FM315S8	55	735	108	0,8	92	2,8	6	3,6	780	1600	325
FM315M8	75	735	149	0,79	92	2,8	6,3	4,1	850	1600	325
FM315MA8	90	735	181	0,78	92	2,8	6,3	5,5	970	1600	325
FM315MB8	110	735	223	0,77	92,5	3	6,8	6,7	1090	1600	325

For dual speed motors or special powers or windings, please contact Coel

Overall Dimensions

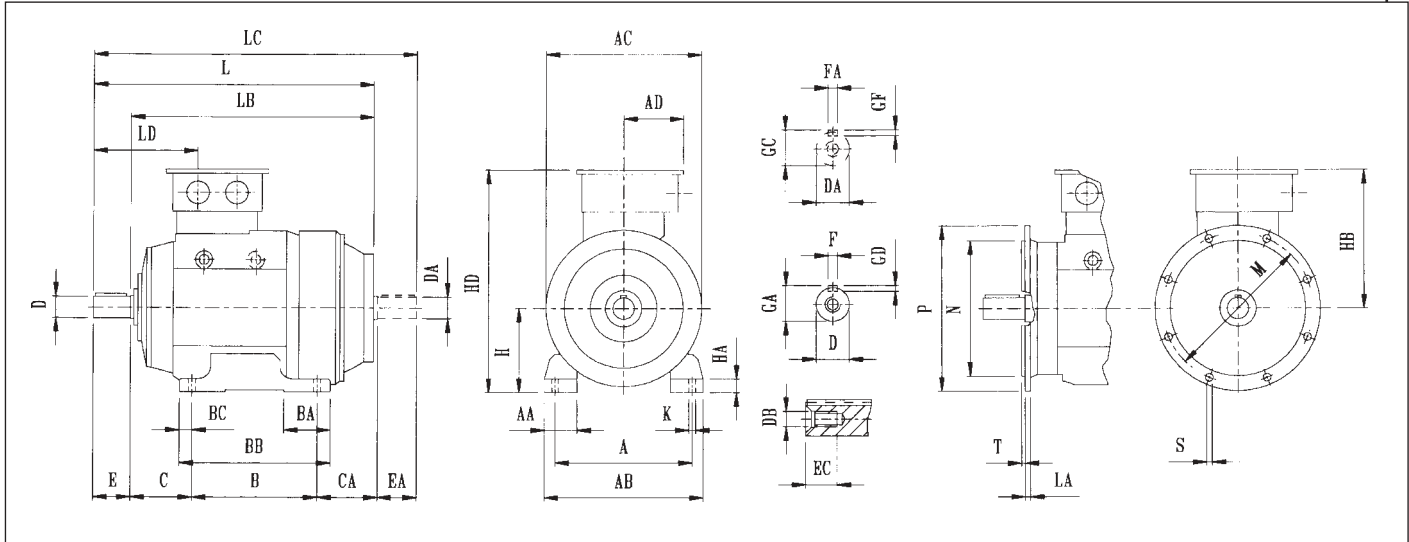

Coupling dimensions

Type	CA				D		DA		DB	E		EA		EC	F		FA		GA		
	A	B	D	1	2	3	4	1		2	1	2	1		2	1	2	1	2	1	2
M225 S	356	286	149	240	240	55	60	42	55	M16	110	140	110	110	35	16	18	12	16	59	64
M225 M	356	311	149	215	215	55	60	42	55	M16	110	140	110	110	35	16	18	12	16	59	64
M225 M	406	349	168	201	201	60	65	42	60	M16	140	140	110	140	35	18	18	12	18	64	69
M280 S	457	368	190	242	267	65	75	48	65	M16	140	140	110	140	35	18	20	14	18	69	79,5
M280 M	457	419	190	191	216	65	75	48	65	M16	140	140	110	140	35	18	20	14	18	69	79,5
M315 S	508	406	216	303	343	65	80	55	80	M16	140	170	110	170	35	18	22	16	22	69	85
M315 M	508	457	216	252	292	65	80	55	80	M16	140	170	110	170	35	18	22	16	22	69	85
M315 MA-MB	508	457	216	372	417	65	80	55	80	M16	140	170	110	170	35	18	22	16	22	69	85

Type	GC		GD		GF		H	K	LA	M	N	P	S	T	AA	AB	BA	BB	BC	HA
	1	2	1	2	1	2														
M225 S	45	59	10	11	8	10	225	18	16	400	350	450	18	5	95	430	110	385	35	35
M225 M	45	59	10	11	8	10	225	18	16	400	350	450	18	5	95	430	110	385	35	35
M250 M	45	64	11	11	8	11	250	22	18	500	450	550	18	5	100	480	115	430	39	38
M280 S	51,5	69	11	12	9	11	280	22	18	500	450	550	18	5	110	530	155	505	42,5	45
M280 M	51,5	69	11	12	9	11	280	22	18	500	450	550	18	5	110	530	155	505	42,5	45
M315 S	59	85	11	14	10	14	315	27	22	600	550	660	22	6	120	590	180	550	46,5	48
M315 M	59	85	11	14	10	14	315	27	22	600	550	660	22	6	120	590	180	550	46,5	48
M315 MA-B	59	85	11	14	10	14	315	27	22	600	550	660	22	6	120	620	180	550	46,5	48

Overall dimensions

Type	AC	AD	HB	HD	L				LB				LC				LD				
					1	2	3	4	1	2	3	4	1	2	3	4	1	2	3	4	
M225 S	425	105	355	580	780	810			1000	1030			895	925			275	305			
M225 M	425	105	355	580	780	810			1030	1030			895	925			275	305			
M250 M	475	105	375	625	855	855			1075	1075			968	998			316	316			
M280 S	520	200	460	740	935	960			1175	1175			1050	1105			348	348			
M280 M	520	200	460	740	935	960			1175	1175			1050	1105			348	348			
M315 S	580	200	485	800	1060	1130			1385	1385			1175	1305			363	393			
M315 M	580	200	485	800	1060	1130			1385	1385			1175	1305			363	393			
M315 MA-MB	645	200	525	840	1160			1235	1190	1485	1065		1020	1295			1430	1385	332	362	362

- 1) Dimensions for 2 poles
- 2) Dimensions for 4,6,8 poles
- 3) Dimensions for 4 poles
- 4) Dimensions for 6,8 poles



Agent or Distributor



Certified quality system UNI - EN ISO 9000-2001

Coel Motori S.r.l.

WORKS

Via Campania, 36/38/40

HEADOFFICE

Via Campania, 40

20090 Fizzonasco di Pieve Emanuele (MI)

ITALY

Tel. +39 **02 90.42.00.39** r.a.

Telefax +39 **02 90.42.07.47**

CODOGNO BRANCH (LO)

Loc. Mirandolina, Via Turati

E-mail: info@coelmotori.it

Internet: www.coelmotori.it

Since **1976** we generate
and stop the motion

THE COPY OF THIS CATALOGUE IS FORBIDDEN.
DATA AND CHARACTERISTICS INCLUDED IN THIS CATALOGUE ARE NOT BINDING AND THEY CAN BE MODIFIED IN ANY MOMENT WITHOUT ANY WARNING